

AXMINSTER

PROfessional

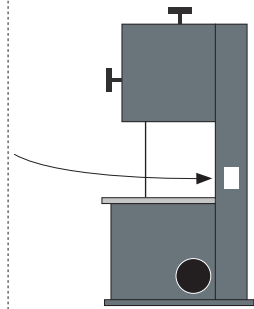
# AP2920B Bandsaw



# INDEX OF CONTENTS

What's In The Box	2 -3
Anatomy	4 - 5
Safety	6
Assembly	7 - 11
Set Up:	
Blade Tension	11
Blade Tracking	12-13
Setting Upper and Lower Blade Guides	13
Thrust Bearing, Upper and Lower	13-14
Aligning the Table to the Blade	14
Squaring the Table to the Blade	15
Aligning the Fence to the Blade	15
Setting Fence Scale	16
Mitre Fence	17
General Use / Operation	18 - 19
Blade Types	20
Blade Change	21 - 22
Troubleshooting	23
Maintenance	23
Exploded Diagram/Parts Lists	24 - 29
Wiring Diagram	29
Declaration of Conformity	30 - 31

The machine's **Serial Number** is located on the specification label as shown.



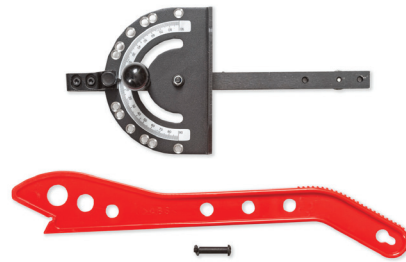
## WHAT'S IN THE BOX

Fig A



Adjustable Feet for Stand and Bolt to Hold Machine to Base

Fig B



Push Stick, Push Stick Fixing Bolt and Mitre Fence

The symbols below advise the correct safety procedures when using this machine.



Fully read manual and safety instructions before use



Ear protection should be worn



Two Man Assembly



Eye protection should be worn



Dust mask should be worn



HAZARD

Fig C



Tool Kit and Stand Fixing Bolts

Fig D



Table Dust Outlet, Hose Ring Clips, Table Insert and Blade Guide Rise and Fall Handwheel

Fig E



Dust Outlet Screws

Fig G



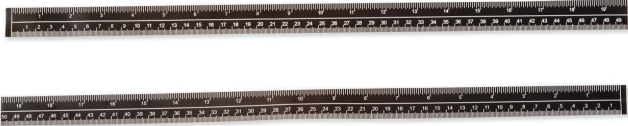
Cast Iron Table with Fence Rail

Fig F



Extraction Hose

Fig I



Self Adhesive Scale Strips for Fence Rail

Fig H



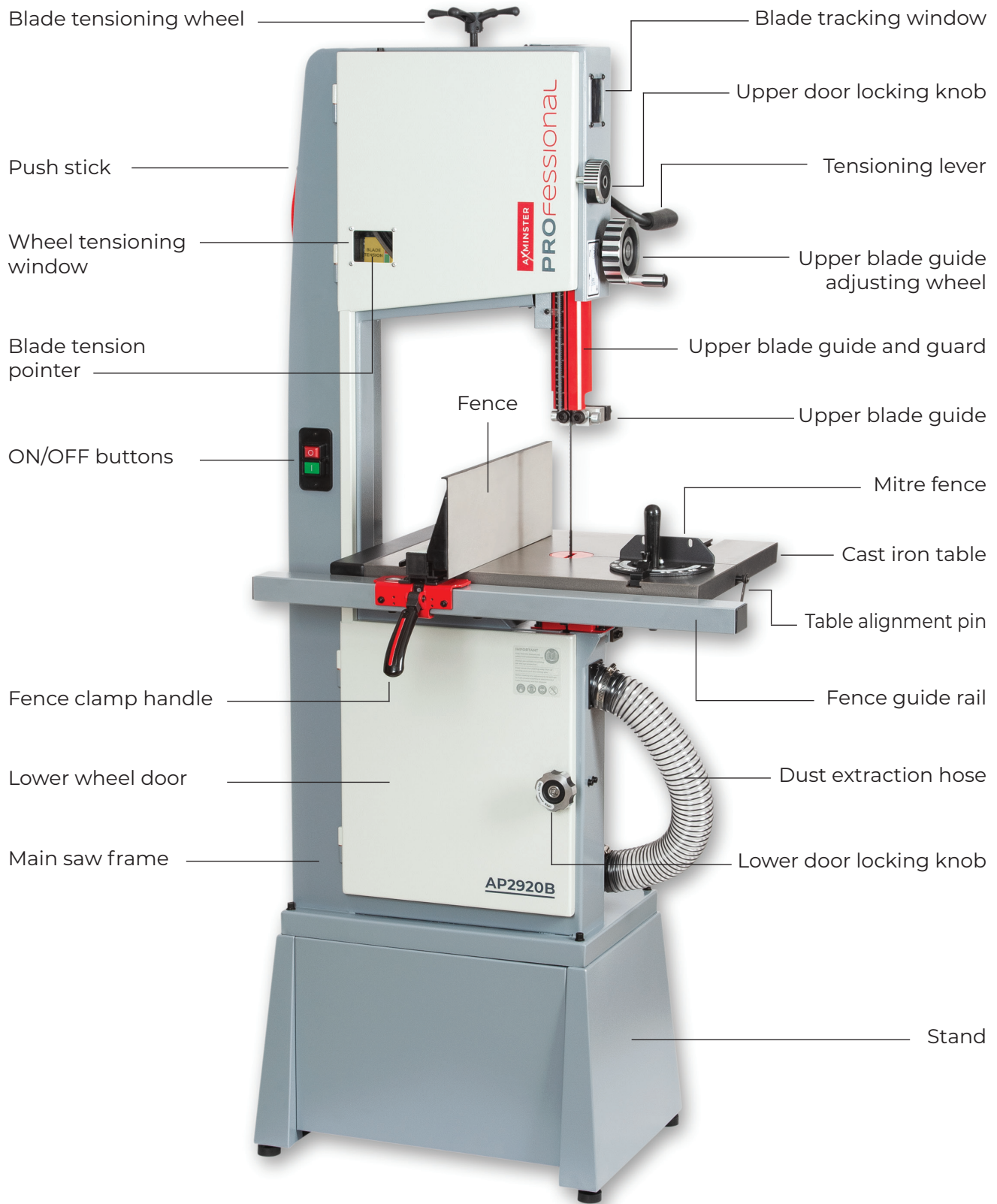
Fence and Fence Lock Assembly

Fig J

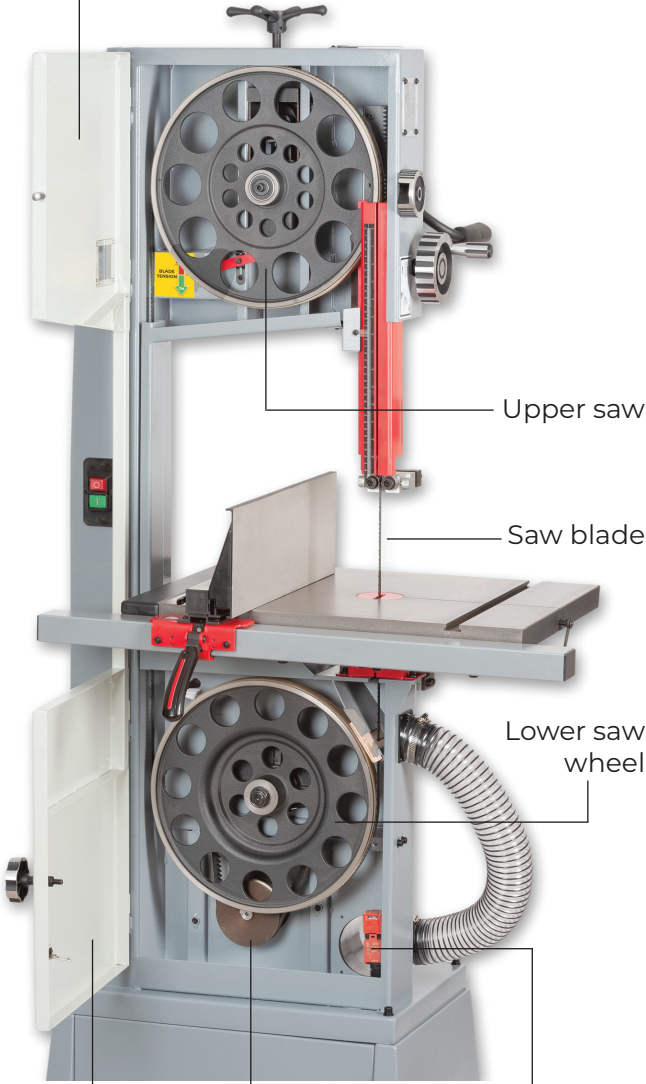


Bandsaw Stand Panels

# ANATOMY



Upper wheel door



Upper saw wheel

Saw blade

Lower saw wheel

Lower wheel door Drive pulley Micro door switch

Tensioning lever



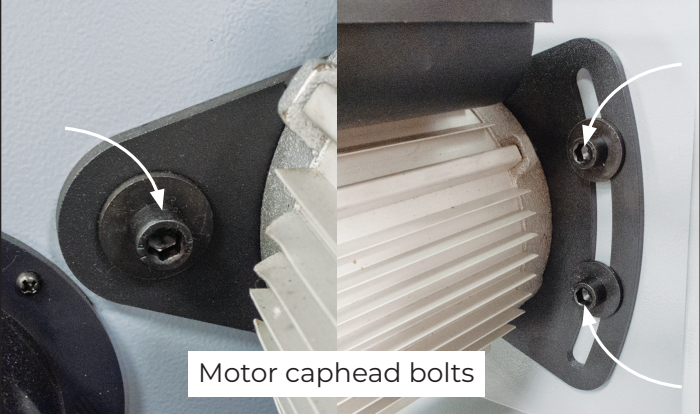
Upper blade guide clamp

Tracking control knob

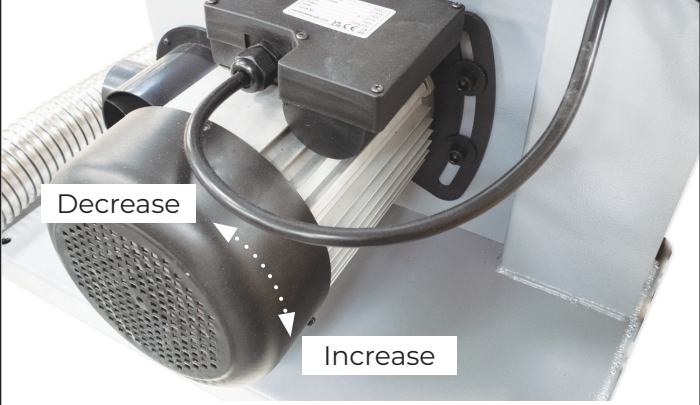
Tracking control lock

Tension the Drive Belt

Loosen the three caphead bolts holding the motor, pivot the motor to increase or to decrease tension on the drive belt. **Note: Check the tension on the belt, there should be a 1/2 inch depression.**



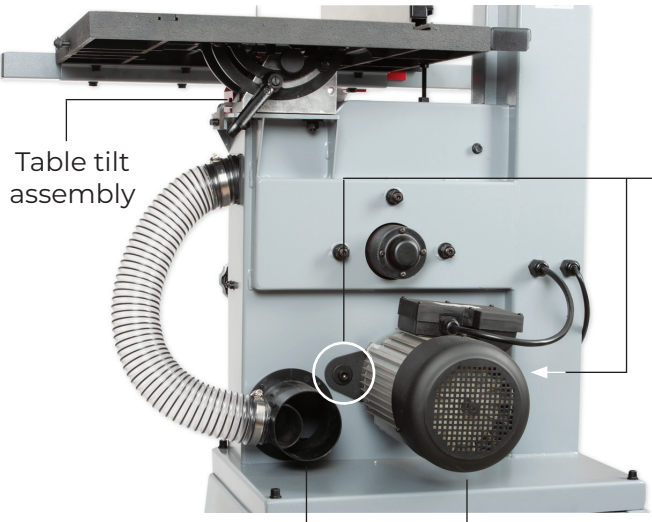
Motor caphead bolts



Decrease

Increase

Table tilt assembly



Dust extraction outlet

Motor



1/2 Inch depression

## SAFETY

---

The following is a list of safety precautions you must consider when using a bandsaw:



**ALWAYS REMEMBER TO DISCONNECT THE POWER TO THE BANDSAW WHEN MAKING REPAIRS OR ADJUSTING BLADES AND GUARDS.**



**ALWAYS REMEMBER TO READ THROUGH THE MACHINE INSTRUCTIONS SUPPLIED.**

- Eye and ear protection are required when operating a Bandsaw. Dust extraction and respiratory PPE are highly recommended.
- Do not wear gloves, loose clothing, jewellery, or any dangling objects when operating a bandsaw.
- Do not allow children to operate the machine.
- All guards must be in place and fully operational. If a guard seems to be missing or damaged, adjust, replace or repair immediately.
- Disconnect the power to the bandsaw when making repairs or adjusting blades and guards.
- Remember to check the blade tension after a new blade has been 'working' for 30-60 minutes. The blade may 'stretch' slightly from new and the tension becomes slack.
- Hands and fingers must be kept clear of the blade, always use push blocks and push sticks when feeding small pieces into the blade.
- Use only the recommended blade size and type for the machine- see page 17-18 for recommendations.
- Ensure all blades are sharp and in good condition.
- The blade guard/guide set must be lowered to approximately  $\frac{3}{4}$ "(20mm) above the workpiece.
- Check that the blade is tensioned and tracked correctly before turning the machine on.
- Never cut pieces smaller than the table insert size.
- Do not attempt to cross cut round timber free hand. Clamp to mitre fence or make a jig to keep the work piece stable.
- Long material should be supported at the same height as the saw table.
- To avoid contact with a coasting blade, do not reach into the cutting area until the blade comes to a full stop.
- Make sure the blade is not in contact with the material when you start the saw.
- Never leave the machine unattended when it is running.
- Keep the table top and surrounding work area free from excessive dust and debris to help prevent slipping or tripping.
- Maintain a balanced stance at all times so that you do not fall or lean against the blade or other moving parts.
- Do not overreach or use excessive force to perform any machine operation.

For more information -<https://www.hse.gov.uk/pubns/wis31.pdf>

## Update - Fence for AP2920B Bandsaw

The Rip fence for the AP2920B Bandsaw has been upgraded to a T-style fence.

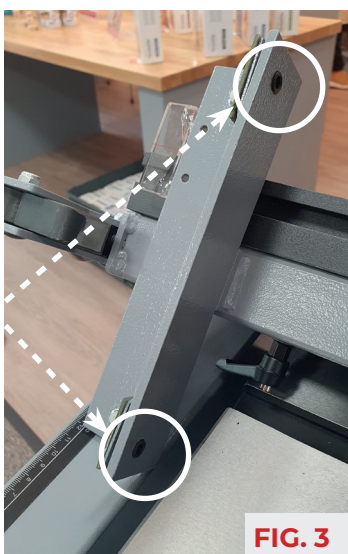
Below are the instructions for squaring to the table and aligning to the blade. (update for page 15)

### Aligning the fence to the blade

1. Ensure that the table aligning instruction has been followed on page 11 of the manual.
2. Place the fence on the machine & slide it over to the mitre fence slot. **FIG. 2**



3. To align the fence to the blade/mitre fence slot the fence has been fitted with 2 grub screws that can be located here. **FIG. 3**



4. Slide the fence over to the mitre fence slot and check for alignment, if the fence seems out of line to the slot, then adjustments can be made by winding either grub screw in or out. **FIG. 4**



### Squaring the fence to the table

5. Ensure that the "squaring the table to the blade" instruction has been followed on page 16 of the manual." Place the fence on the machine & slide it over then lock it off around 100 – 150mm from the blade, check for square with the fence in its high position. **FIG. 1**



6. If the fence seems out of square to the table, then adjustment can be made by firstly unlocking the fence then winding the 2 nylon grub screws in or out. Adjust, relock then recheck for square, adjust again if needed. **FIGS. 5 & 6**

# ASSEMBLY

## Stand Assembly

1. Fix the adjustable feet to each stand end panel, (fig 01).

**Fig 01**



2. Fix the stand side panels to the end panels using the eight bolts, washer and nuts, (fig 02-05).

**Fig 02-03**



**Fig 04-05**






### Attaching Stand to Bandsaw

1. Lay the bandsaw on its back to attached the stand assembly to bandsaw with the four stand Hex bolts and washers, (fig 06-07-08).

Fig 06-07-08



2. Lift bandsaw vertical, (fig 09).

 **THE BANDSAW IS A HEAVY PIECE OF EQUIPMENT, IT IS ADVISABLE TO GET ASSISTANCE.**

 **TWO MAN ASSEMBLY REQUIRED.**

Fig 09



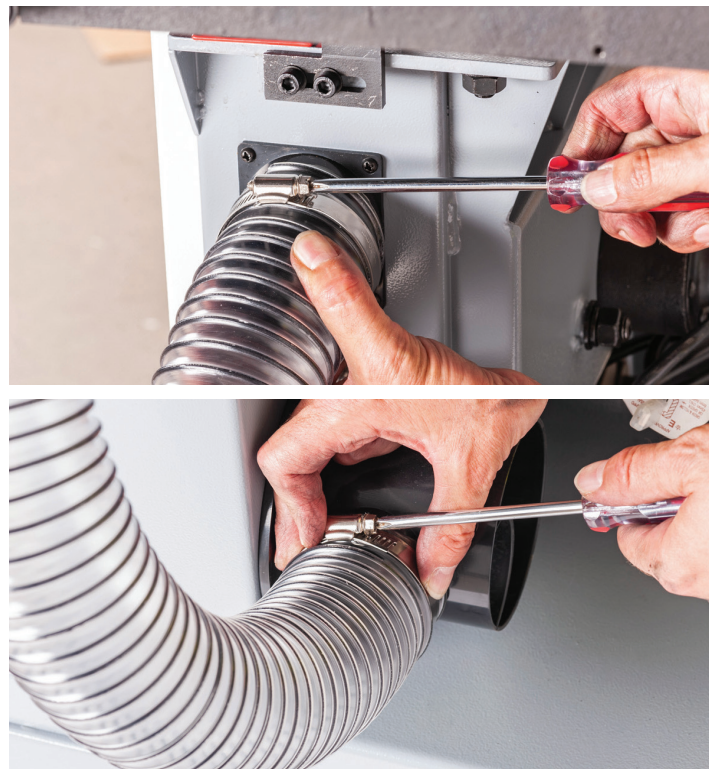
3. Attach the dust outlet below the table with the four screws provided, (fig 10).

Fig 10



4. Attach each end of the hose to the table's dust extraction outlet's using the two ring clips, (fig 11).

Fig 11-12



Continues over...

## ASSEMBLY

5. Line-up the holes to the underside of the cast iron table with the ones in the trunnions and secure in place with four button head Hex bolts/washers, (fig 13-14).

**Fig 13-14**



6. Locate the table insert and place it into the centre of the table, (fig 15).

**Fig 15**



7. Find the fence locking assembly and slide it into position on the fence rail as shown, (fig 16).

8. Loosen the two lift and shift handles on the fence locking assembly. Line-up the 'T' slot to the base of the fence and slide it over the mounting plate to the desired position. Nip-up the lift and shift handles to secure the fence, (fig 17-18).

**Fig 16-17-18**



9. Locate the Rise and Full handle wheel, loosen the two grub screws around the mounting boss. Line up the grubs crews with the machined flats on the drive shaft and slide the unit on. Nip-up the screws to secure in place, (fig 19-20).

**Fig 19-20**



10. Find the threaded hole to the side of the bandsaws column. Locate the push stick holding screw and screw it into the column, hook the push stick over the screw, (fig 21-22).

Fig 21-22



SET UP

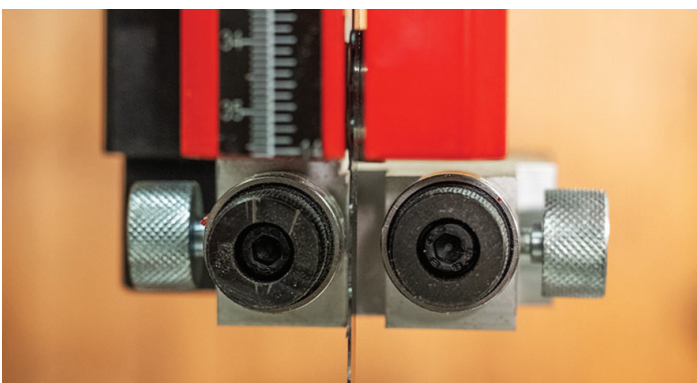
Blade Tension



DISCONNECT THE MACHINE FROM THE MAINS SUPPLY.

Ensure that all guide bearings are well clear of the blade!, (fig 23).

Fig 23-24



Position the tension lever down in full tension position, (see fig 24).



- Before altering blade tension ensure that the blade is roughly positioned in the middle of the wheel, you will need to lower the top wheel slightly by using the tension lever to do this, (fig 25).
- Turn the blade tension knob clockwise to tension the blade whilst rotating the top wheel slowly at first by hand. A gauge at the front of the upper wheel shows either tension on or tension off, (fig 26).
- The best place to check blade tension is on the left hand side of the bandsaw. Around 1cm of blade movement is recommended, (fig 27).
- Changes in blade width will have an effect on blade tension. Keep in mind that too little blade tension can cause blade breakage.
- After a period of use it is recommended to recheck the blade tension and possibly readjust as bandsaw blades can stretch slightly in use.

**TIP:** If the bandsaw is to sit idle for a period of time, place the tension lever in partial tension position; this will help prevent blade fatigue and tyre deformation, and save wear on bearings and band wheels.

Fig 25

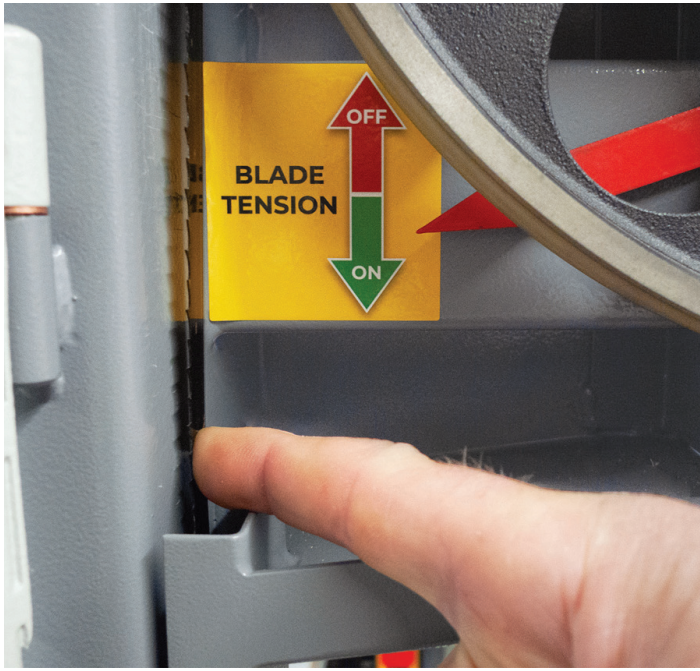


Fig 26



## SET UP

Fig 27



### Blade Tracking



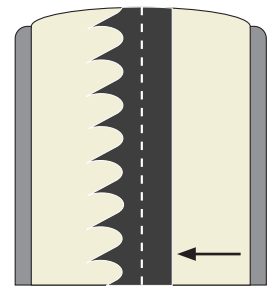
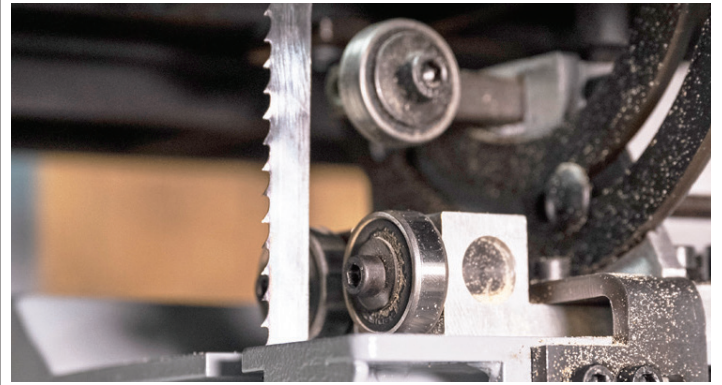
**DISCONNECT THE MACHINE FROM THE MAINS SUPPLY.**

- Do not adjust blade tracking with the machine running. "Tracking" refers to how the blade is positioned on the wheels whilst running.
- The blade should track approximately in the centre of both wheels, as shown in (fig 28) Tracking on the Bandsaw should be checked periodically, included as part of every blade change.
- The blade must be properly tensioned before adjusting blade tracking. Make sure blade guides bearings are opened up, backed off and are well clear of the blade, (fig 29)
- Open the upper door and rotate the upper wheel slowly at first clockwise by hand. Observe the position of the blade on the wheel - it should be in the centre, (fig 30-31).

Fig 28



Fig 29-30-31



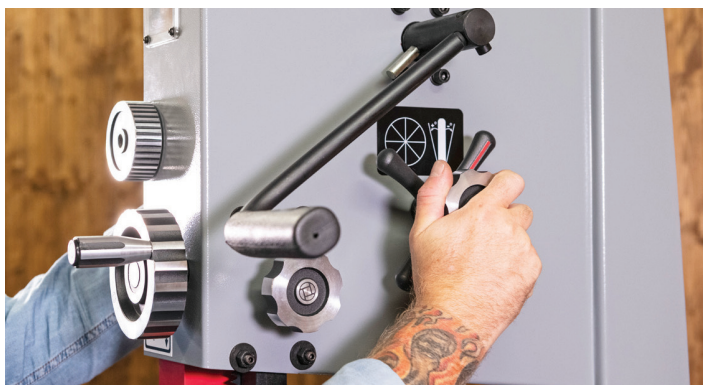
Blade  
approximately  
centred

- If the blade tends to shift to one side or the other of the wheel, slight adjustment will need to be made, start by loosening the locking knob, (fig 32).
- If the blade is tracking toward the front edge of the wheel, rotate the tracking knob clockwise – the upper wheel will tilt toward the back and the blade will move to the centre of the wheel. If the blade is tracking toward the back edge of the wheel, rotate the tracking knob counterclockwise: the upper wheel will tilt toward the front and the blade will move toward the centre of the wheel, (fig 33).

Fig 32



**Fig 33**



• **IMPORTANT:** This adjustment is sensitive; perform it in small increments and give the blade time to react to the changes, as you continue to rotate the wheel.

- When the blade is tracking properly at the centre of the wheel, re-tighten the locking knob, (fig 34).
- Turn on the saw and verify proper tracking while the machine is running.
- If further tracking adjustments are needed, disconnect from power, and repeat instructions above.

**Fig 34**



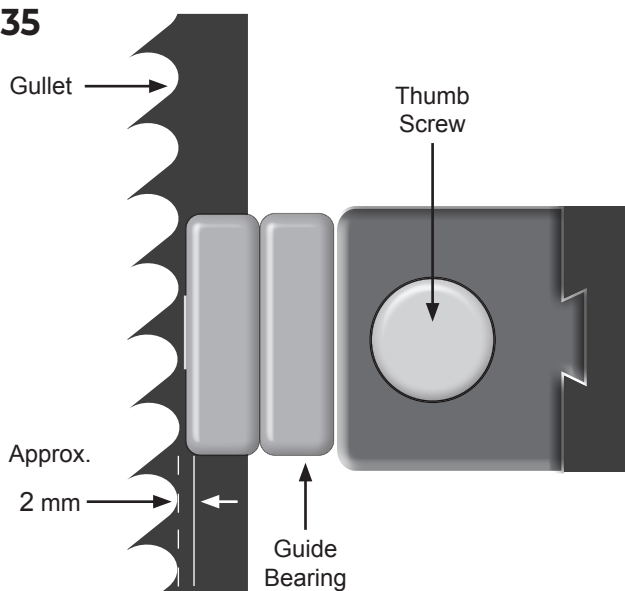
**Setting Upper and Lower Blade Guides**

**Both top and bottom bearing blade guides will be set in exactly the same position.**

 **DISCONNECT THE MACHINE FROM THE MAINS SUPPLY.**

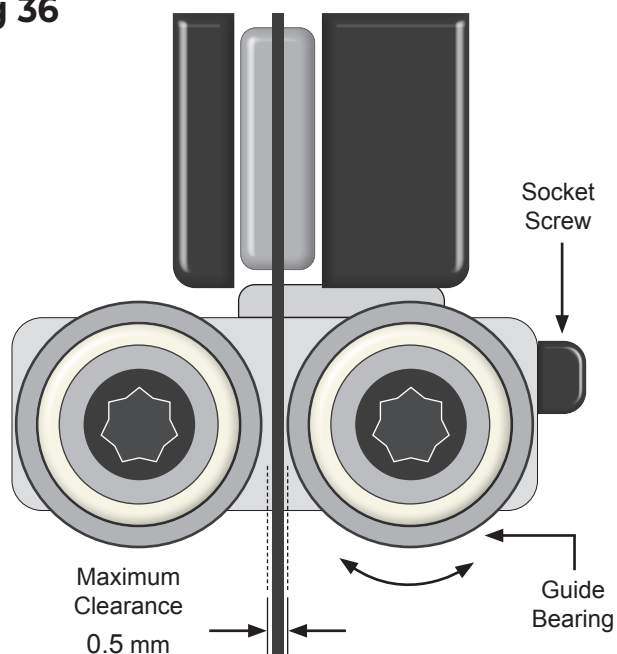
- Blade must be tensioned and tracked properly.
- Loosen thumb screw and move guide block by turning the knob so that the front face of the guide bearings are approximately 2mm behind the gullet (curved area at base of tooth) of the blade, tighten thumb screw, (fig 35).

**Fig 35**



- Loosen the socket screw and position each guide bearing so that it is no more than 0.5mm away from the blade, very close but not quite touching the blade. A quick way to set this distance is to use a piece of breakfast cereal packet cardboard between the blade and bearing, which is approximately 0.3mm thick, (fig 36).
- Tighten socket screw when adjustment is satisfactory.

**Fig 36**



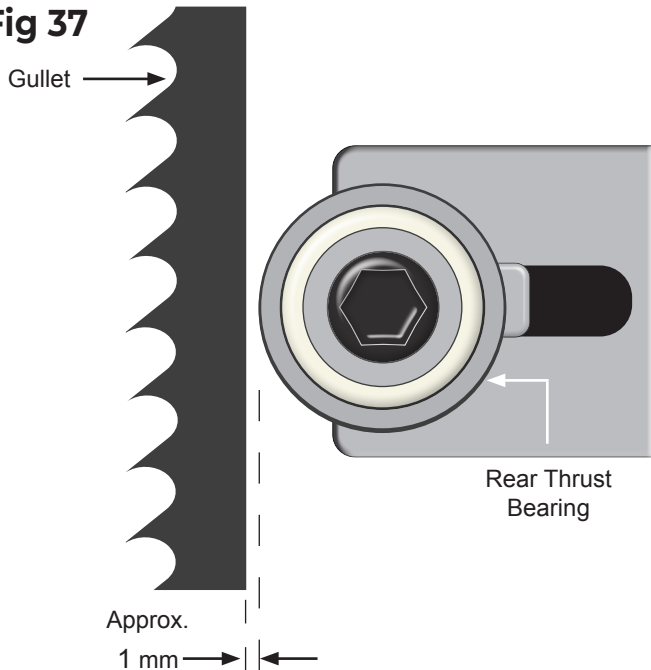
**Thrust Bearing, Upper and Lower**

The thrust bearing supports the back edge of the blade during operation, and is set so that the blade will contact it only when the blade is under pressure during a cut.

## SET UP

- Loosen thumb screw and turn knob to move the thrust bearing in or out until the bearing is approximately 1mm behind the blade, tighten thumb screw, (fig 37).

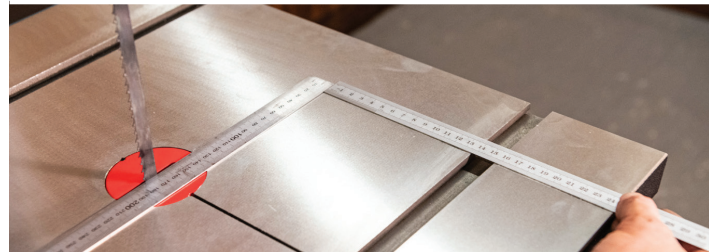
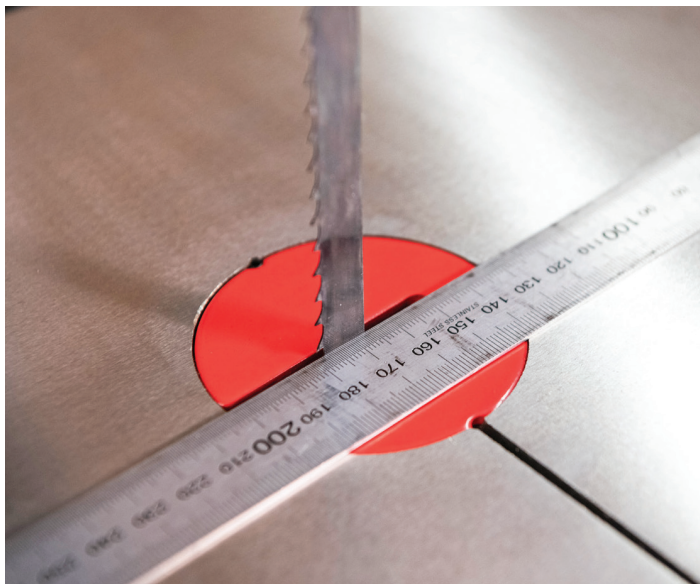
**Fig 37**



### Aligning the Table to the Blade

- Place a straight edge along the side of the blade ( $\frac{1}{2}$ " width blade or wider), with very light pressure (do not deflect the blade). The straightedge should contact both the front and back of the blade but sit between the teeth, (fig 38).
- Measure carefully with a fine rule from the straightedge to the edge of the mitre slot, do this at the front and back of the table; the distance should be the same, (fig 39).

**Fig 38-39**

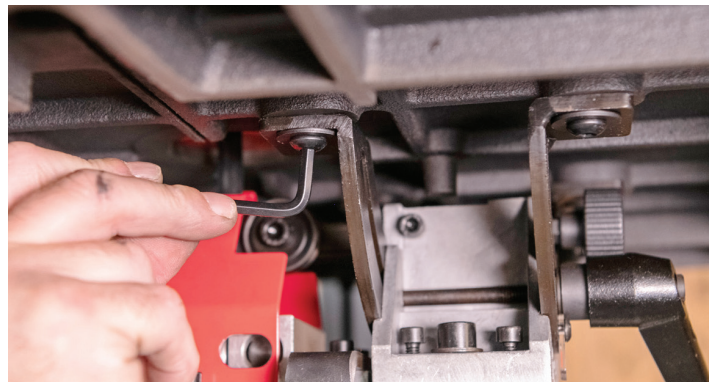


- If the mitre slot is not aligned with the blade, slightly loosen the four screws holding the trunnions to the table, (fig 40).

- Nudge the table as needed, until the mitre slot is aligned with blade (distances are the same front to back), (fig 41).

- Tighten trunnion screws. **(NOTE: After this adjustment, the alignment of fence to blade may need to be re-checked. See "Aligning Fence to Blade section"**

**Fig 40-41**



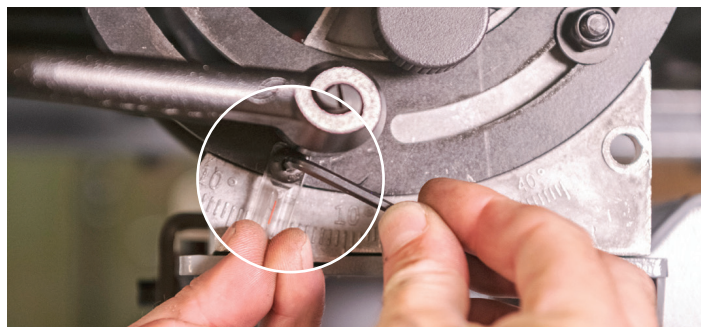
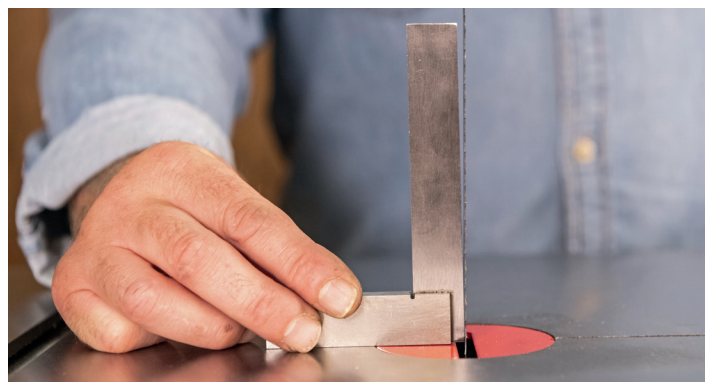
### Squaring the Table to the Blade



**DISCONNECT THE MACHINE FROM THE MAINS SUPPLY.**

- Loosen table locking knobs and tilt table to the left (down flat) until it rests against the table stop screw (fig 42).
- Use a square placed on the table and against the left hand side of the blade (fig 43) verify that the table is 90 degrees to the blade. Make sure the table insert is level with the table surface or removed to ensure an accurate reading.
- If an adjustment is necessary, tilt the table and tighten the table locking knobs.
- Loosen the lock nut and turn the table stop screw left or right to raise or lower the stop, raising or lowering the table height when in the down position, tighten lock nut down against the trunnion/table to hold table stop screw in place, (fig 44).
- Unlock the table and tilt it back on to the table stop screw to confirm the table is 90 degrees to the blade. Repeat this process as necessary until the table is at 90 degrees to the blade.
- Adjust the pointer indicates zero, (fig 45).

**Fig 42-43-44-45**



### Aligning the Fence to the Blade

- Line up the fence with the edge of the tables mitre fence slot and press down the locking handle, (fig 46).
- If the fence is out of alignment, loosen the four Hex screws either side of the fence clamping assembly, (fig 47).
- Adjust the fence until its in alignment with the mitre fence slot, retighten the Hex screws, (fig 48).

**Fig 46-47-48**



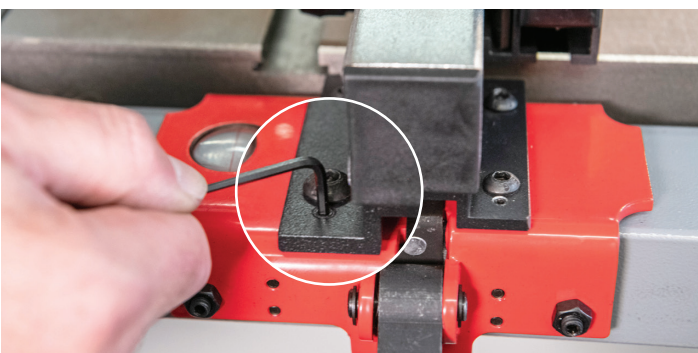
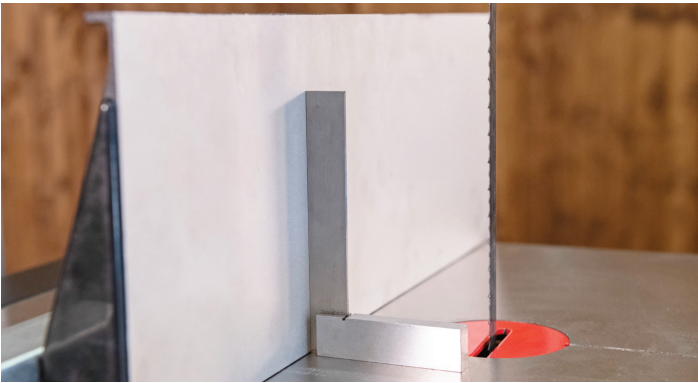
## SET UP



### Squaring the Fence to the Table

- Check to see if the fence is square to the table, (fig 49).
- If not square, adjustments are made by firstly slackening the four fence bolts, (fig 50).
- Adjust the four alignment grub screws until the fence is square. Nip-up the fence bolts, (fig 51).

**Fig 49-50-51**

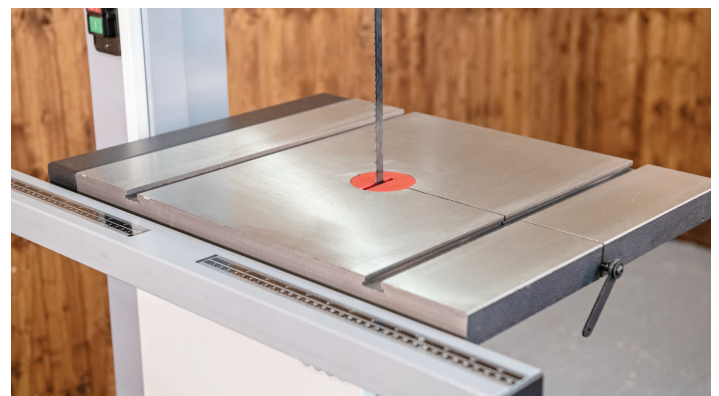
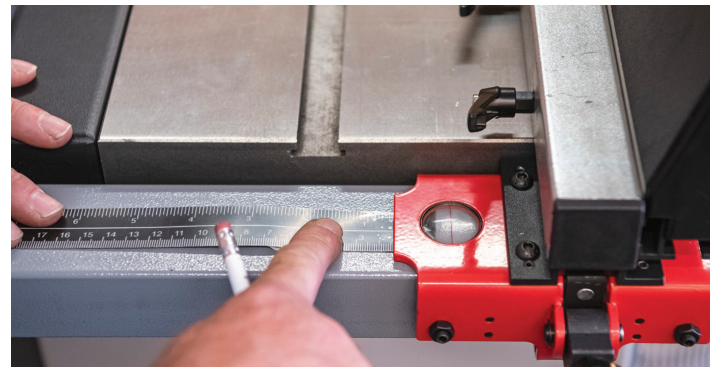


### Setting Fence Scale -

Once the table and fence are squared and aligned you can attach the self adhesive scale to the fence rail.

- Attach the fence to the fence rail and slide it over to lightly touch the blade, ensure that the blade to fence contact is very light - do not deflect the blade.
- Slide the scale under the fence to bring the zero mark to the red line in the lens, (fig 52).
- Make a pencil mark at any given point, (fig 53).
- Remove the fence then stick the scale to the fence rail bringing it back to the pencil mark and using a sharp knife trim off excess scale, (fig 54).
- Repeat for both right hand and left hand fence use, (fig 55).

**Fig 52-53-54-55**



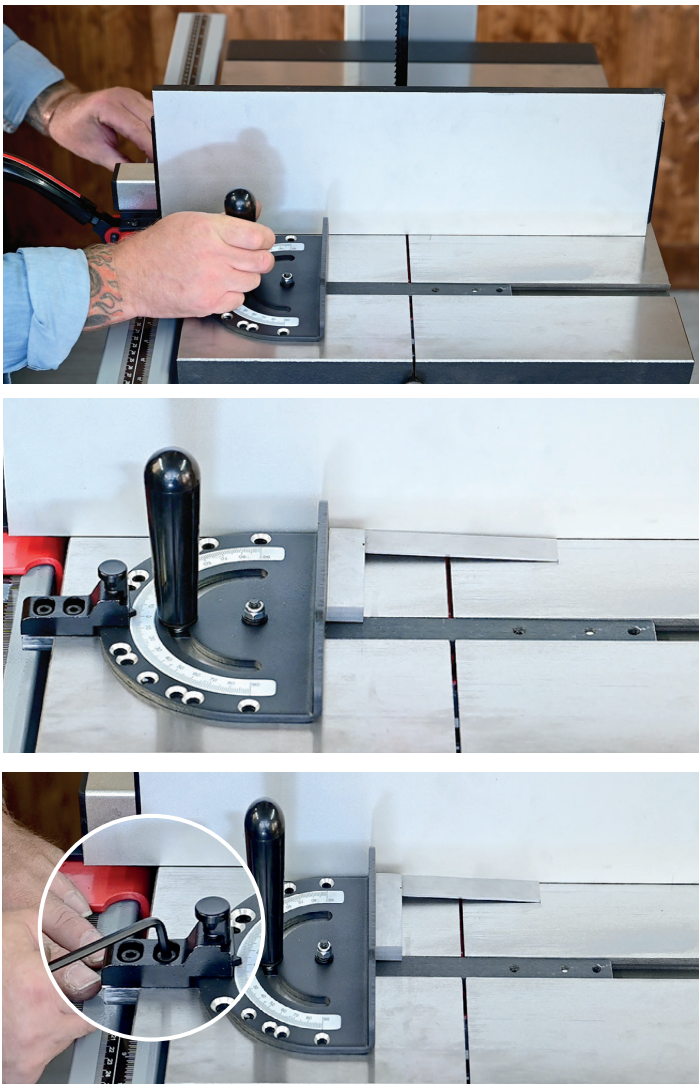


## Mitre Fence

- Slide the mitre fence into the slot around half way along the table, (fig 56).
- Move the rip fence over close to the blade.
- Place a square against the mitre fence and rip fence and check they are square, (see fig 57).

If adjustment is required, unlocking the main handle then undo the two hex cap screws, pivot the mitre fence until it looks square against the rip fence, lock all in place, (fig 58).

**Fig 56-57-58**



## General use / operation

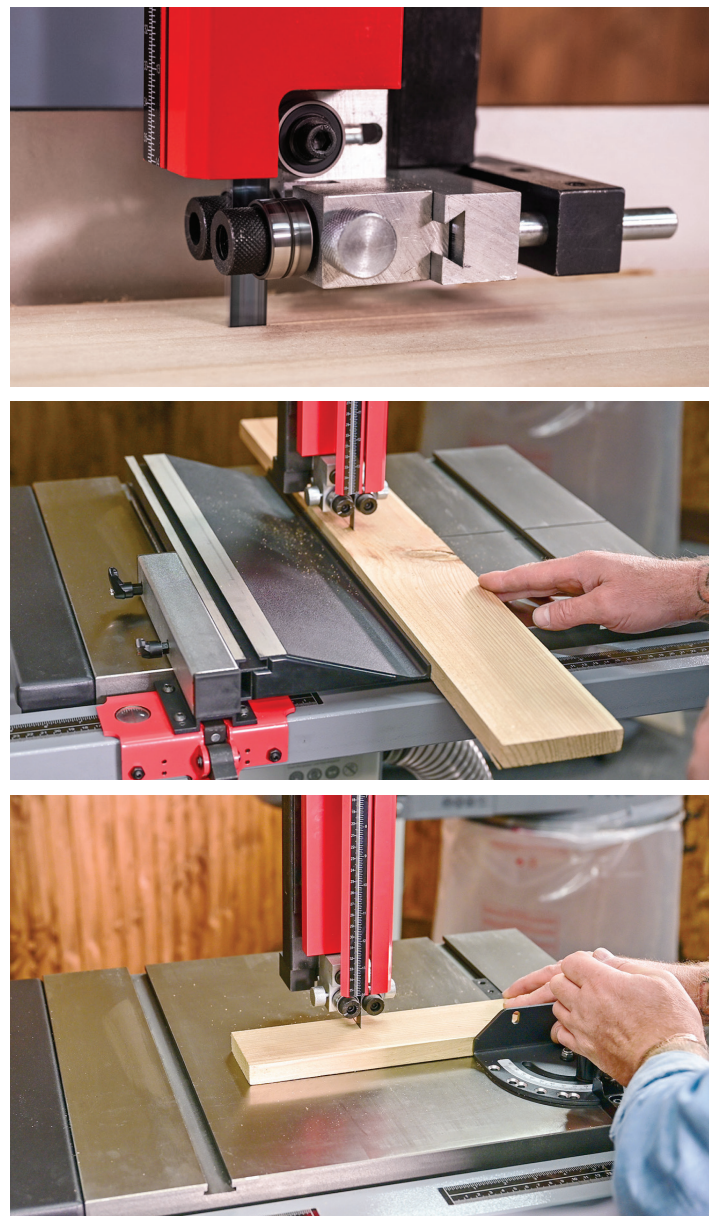
The following section contains basic information, and is not intended to cover all possible applications or techniques using the Bandsaw. Consult published sources of information, acquire formal training, and/or talk to experienced Bandsaw users

to gain understanding and knowledge of bandsaw operations.

Firstly ensure that you have the right blade fitted for the intended cut - see the blade selection guide on pages 17-18.

- Make sure the blade is adjusted correctly tensioned and tracking, and that upper and lower guide bearings and thrust bearings are set in proper relation to the blade. Adjust guide post so that the guide bearings are just above the workpiece, about  $\frac{3}{4}$ " (20mm) allowing minimum exposure to the blade but maximum support during the cut, (fig 59).
- If using the fence, move it into position and lock it to the fence rail. If you are using the mitre gauge for a crosscut, the rip fence would usually be moved safely out of the way, (fig 60-61).

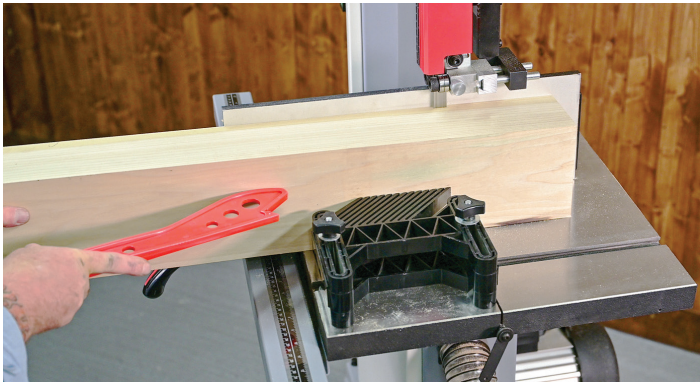
**Fig 59-60-61**



## GENERAL USE / OPERATION

- Turn on the bandsaw and allow a few seconds for the machine to reach full speed.
- Whenever possible, use a push stick, hold-down, jig, or similar device while feeding timber, to prevent your hands getting too close to the blade, (fig 62-63).

**Fig 62-63**



- Place the straightest edge of the workpiece against the fence for a rip cut; or against the mitre gauge for a crosscut. Push the workpiece slowly into the blade, while also keeping it pressed against the fence or held against the mitre gauge. Do not force the workpiece into the blade, always feed through at a slow and steady pace, (fig 64-65).

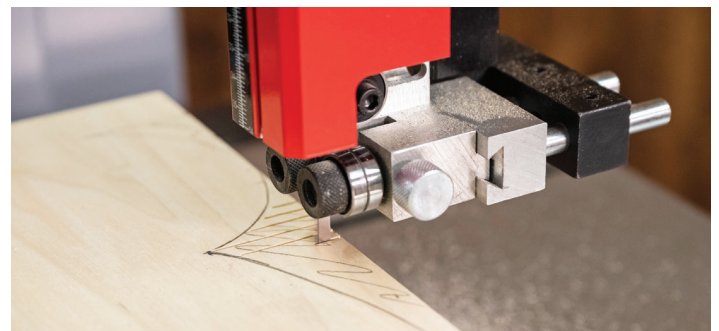
**Fig 64-65**



### Tips:

- Make relief cuts whenever possible. A relief cut is an extra cut made through the waste portion of a workpiece up to the layout line. When that intersection is reached by the blade while following the layout line, the waste portion comes free. This helps prevent pinching of the back edge of the blade in the cut, (fig 66).
- When cutting, do not overfeed the blade; overfeeding will reduce blade life, and may cause the blade to break.
- Stand at the corner of the machine when making rip or re-saw cuts using the rip fence, this will help ensure that the timber stays in contact with the fence for the full cut, (fig 67).
- When cutting long timber, the operator should use roller stands, support tables, or an assistant to help stabilise the workpiece, (fig 68).

**Fig 66**



**Fig 67**

**Fig 68**



## Ripping cuts

Ripping is cutting lengthwise down the workpiece, and with the grain. Always use a push stick or similar safety device when ripping narrow pieces. Rip cuts can also be made “freehand” following a pencil line but you will find far more accurate results if a fence is used, (fig 69).

**Fig 69**



## Resawing

- Resawing is the process of slicing timber to reduce its thickness, or to produce boards that are thinner than the original timber, such as veneers and book matching. The ideal blade for resawing is the widest one the machine can handle, as the wider the blade the better it can hold a straight line, a fairly coarse tooth (3-4 TPI) is recommended for this cut, (fig 70).

- Resawing is always performed using the rip fence, use a push stick and often a feather board to ensure straight safe cuts. Keeping your hands away from the blade, (fig 71).

**Fig 70-71**



## Crosscutting

- Crosscutting is cutting across the grain of the timber, usually whilst using the mitre gauge to feed the timber into the blade. The right hand should hold the workpiece steady against the mitre gauge, while the left hand pushes the mitre gauge past the blade. Cross cuts can also be made “freehand” following a pencil line but you will find far more accurate results if a mitre fence is used (fig 72).

**Fig 72**



## Freehand Curve Cutting

- Curve cutting is something all bandsaws do very well in both shallow and deep timber with the correct blade installed. An ideal curve cutting blade is a ¼” x 6 TPI - the narrower the blade the tighter curve it can cut.

- No fences are used making these cuts and usually no push sticks either so it is very important to ensure that your hands remain as far away from the blade as possible. If the timber is too small or the curve too tight then the cut is better made on a Scroll saw, (fig 73).

**Fig 73**



## BLADE TYPES



# BANDSAW BLADES

As with all cutting machines, one of the key factors is the quality of your blade. The use of a sharp, high quality blade of the correct tooth pitch is critical for achieving a clean accurate cut, every time.

Our Axc caliber Bandsaw Blades encompass all the qualities you rely on:

**QUALITY** All our bandsaw blades are rolled carbon steel banding from a Coventry rolling mill and have teeth either milled or diamond ground.

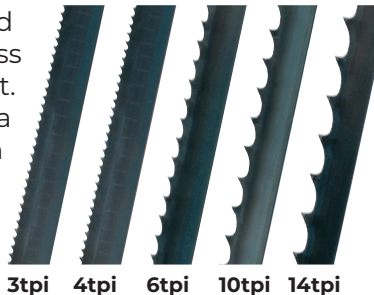
**DURABILITY** Banding is subjected to a hardening and annealing process to give durability to the teeth.

**ACCURACY** The banding is checked by specialist machinery to ensure perfect tolerances.

**MANUFACTURING** Material is sized, sized, welded, finished and packed and ready to be despatched to our customers at our in-house facility in Axminster, U.K.



**TOOTH PITCH** is decided by the type and thickness of the material being cut. For woods and plastics, a minimum of three teeth should be in the cut, for example, for ½" thick wood, use six teeth per inch.



### GETTING THE MOST OUT OF YOUR BLADE

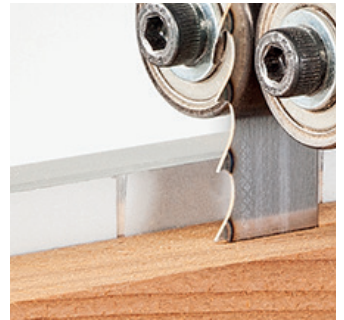
- Use a clean sharp blade – change it regularly and remove resin deposits
- Select the correct length and teeth for the job
- Use separate blades for straight and curved cuts
- Position and tension the blade correctly, use a tension gauge where possible
- Let the blade do the cutting, don't force the wood through the cut
- Release tension when the saw is not in use for long periods
- Use dust extraction and remove waste from your machine's casting

### Blade Types

**GROUND TOOTH** – Unique to Axminster, the diamond ground teeth stay sharper for 30% longer, ensuring a clean cut and exceptional finish in most materials.



**HIGH CARBON** – Our general purpose blade, ideal for many workshop tasks.



**PREMIUM** – Made from M42 high speed steel with 8% cobalt, these blades will cut all materials with ease, including metal at the right speed. All feature variable pitch teeth for a wider range of applications.



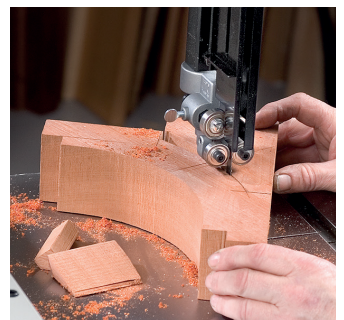
**BACK TOOTH** – These blades have small teeth on the back to clear the debris of the cut and are ideal for tight curves such as woodturners wanting to make their own blanks.



**RIPPER 37** – Specifically for larger machines with high motor capacity, these blades are perfect for wood ripping processing and deep ripping tasks.



**FRESH CUT 37 GT** – Featuring diamond ground teeth and a light teeth set and hook configuration. Ideal for very clean rip cuts with minimal waste due to the thin kerf. Suitable for all ripping tasks, with a longer life-span than normal milled tooth blades.





**DISCONNECT THE MACHINE FROM THE MAINS SUPPLY.**

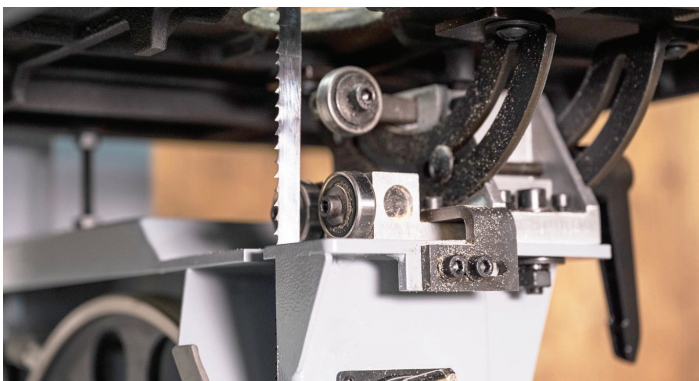
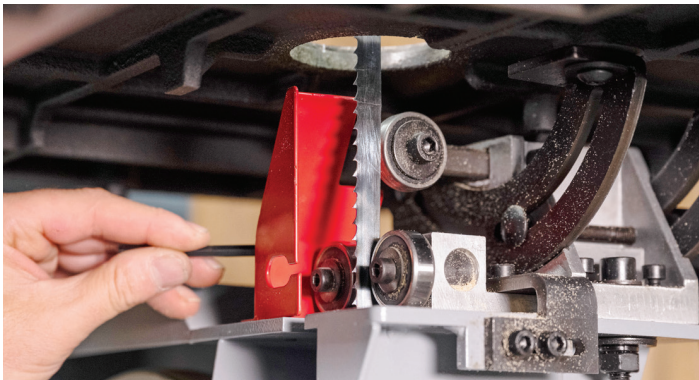
## Removing Blade

- Open the doors
- Adjust the upper blade guide set so that it is around half way down, (fig 74).
- Remove the lower blade guards and open up/back off all blade guides so that they are clear of the blade, (fig 75-76).

**Fig 74**

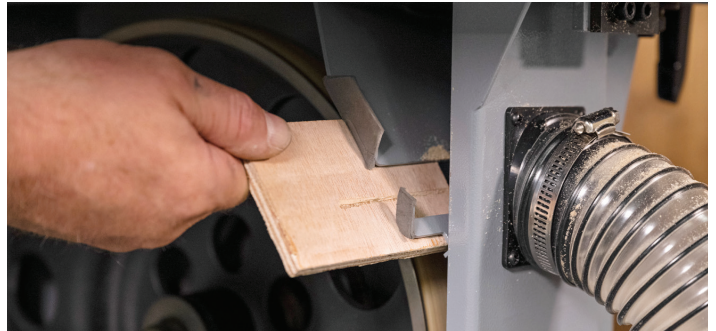
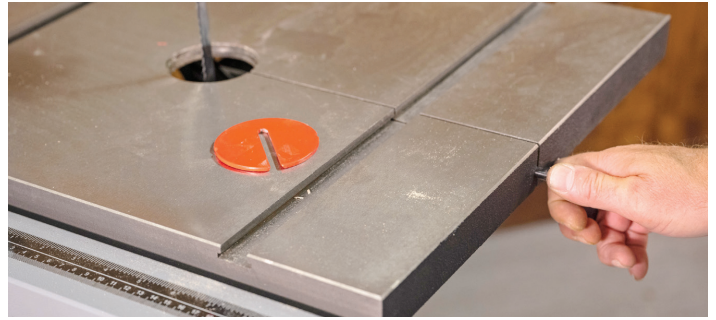


**Fig 75-76**



- Remove the table insert, table alignment pin and wooden plate, (fig 77-78).
- Use the tension lever to de-tension the blade, (fig 79).

**Fig 77-78**

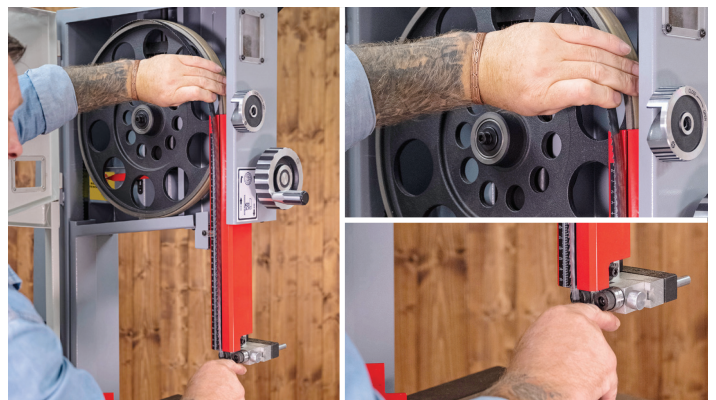


**Fig 79**



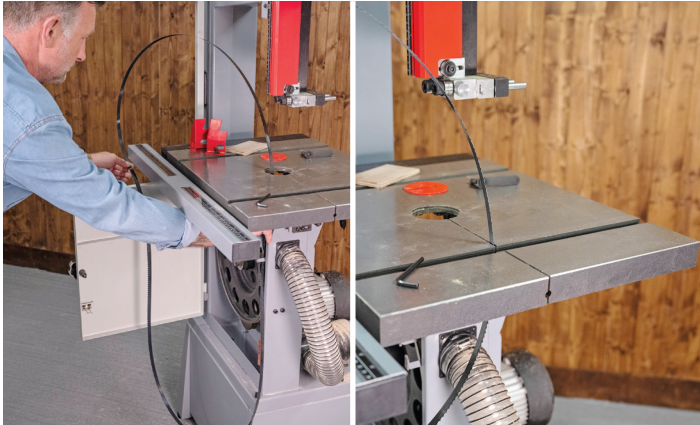
- Slide the blade forward clear of both wheels and through the right hand guard slot (fig 80). Bring the left hand side of the blade through the slot and around towards the right hand side of the machine then guide the blade through the table slot, (fig 81-82).

**Fig 80**



# BLADE CHANGE

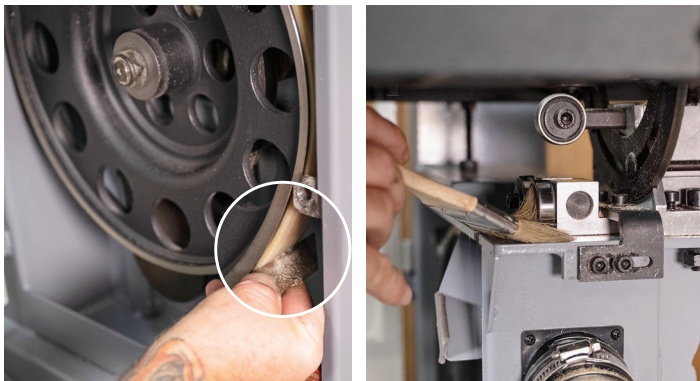
**Fig 81-82**



- Clean crud from the tyres and remove any small off cuts that may be around the bottom blade guide set, (fig 83-84).

- Use the blade selection guide on pages 17-18 to ensure that you have the right blade for the job!

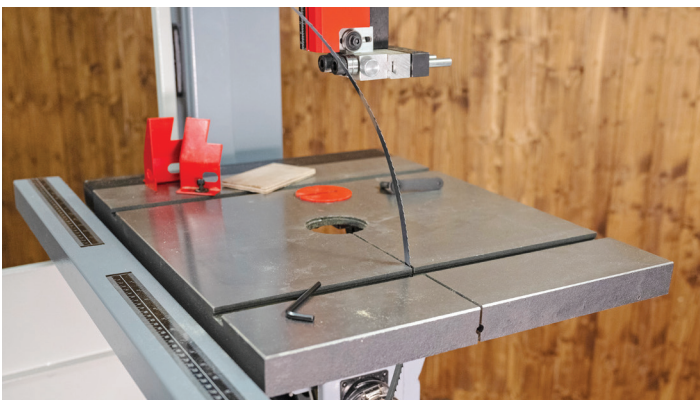
**Fig 83-84**



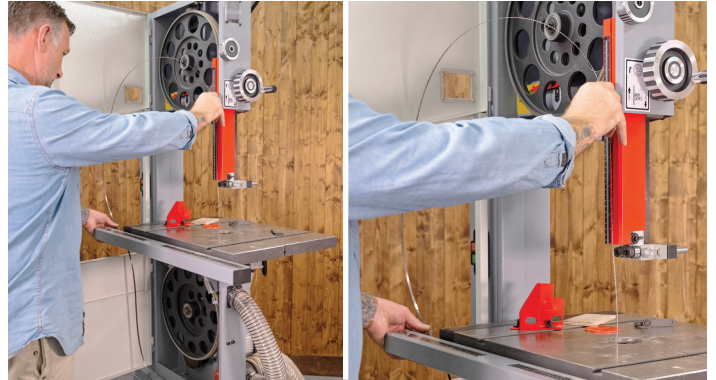
## Fitting the new Blade

- Slide the new blade through the table slot taking care not to twist or distort the blade, then guide the left hand side of the blade around toward the machine and through the slot at the spine of the machine, (fig 85-86-87).

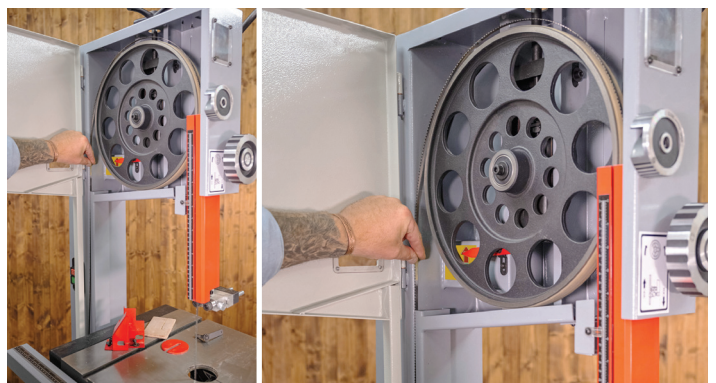
**Fig 85**



**Fig 86**



**Fig 87**



- Guide the blade through the upper blade guard and both the top and bottom blade guides positioning the blade approximately in the middle of firstly the top and then the bottom of the wheel, (fig 88).

**Fig 88**



- Apply blade tension using the tension lever then fine tune using the tension / tracking guide on pages 08-09-10.

- Reattached the table insert, the table alignment pin and wooden plate then close the doors.

Bandsaws are relatively simple machines and with all machinery regular servicing (preventative maintenance) is essential to get the best from your saw.

	<b>“My bandsaw won’t cut straight”</b>
●	This is the most common question that you will get from bandsaw users. Usually the answer lies within the blade; poor quality blades with uneven set, the blade is blunt or damaged often only on one side, the tooth count is far too high for the material being cut -remember 2 teeth minimum and 10 teeth maximum in the work piece.
●	The fence is out of line with the blade.
●	Increase blade tension

	<b>“My bandsaw vibrates”</b>
●	Clean machine wheels.
●	Check blade is running correctly on wheels.
●	Check blade weld – is it in line?
●	Check machine is not on an uneven floor.

	<b>“My bandsaw slows down when cutting”</b>
●	Check drive belt is tensioned correctly, see page 5.
●	If cutting hard or wet material, slow your feed rate down.
●	Check blade is sharp and not too fine.
●	Make sure that when curve cutting a narrow blade is used- pages 17-18 blade and cutter types.

	<b>“Can I cut steel on my bandsaw?”</b>
●	No , most woodcutting bandsaws run far too fast to cut steel, even if a metal cutting blade is fitted.

	<b>“Getting blade breakage?”</b>
●	Blade tension too slack.
●	Blade guides misaligned.
●	Feeding timber too quickly.

## MAINTENANCE

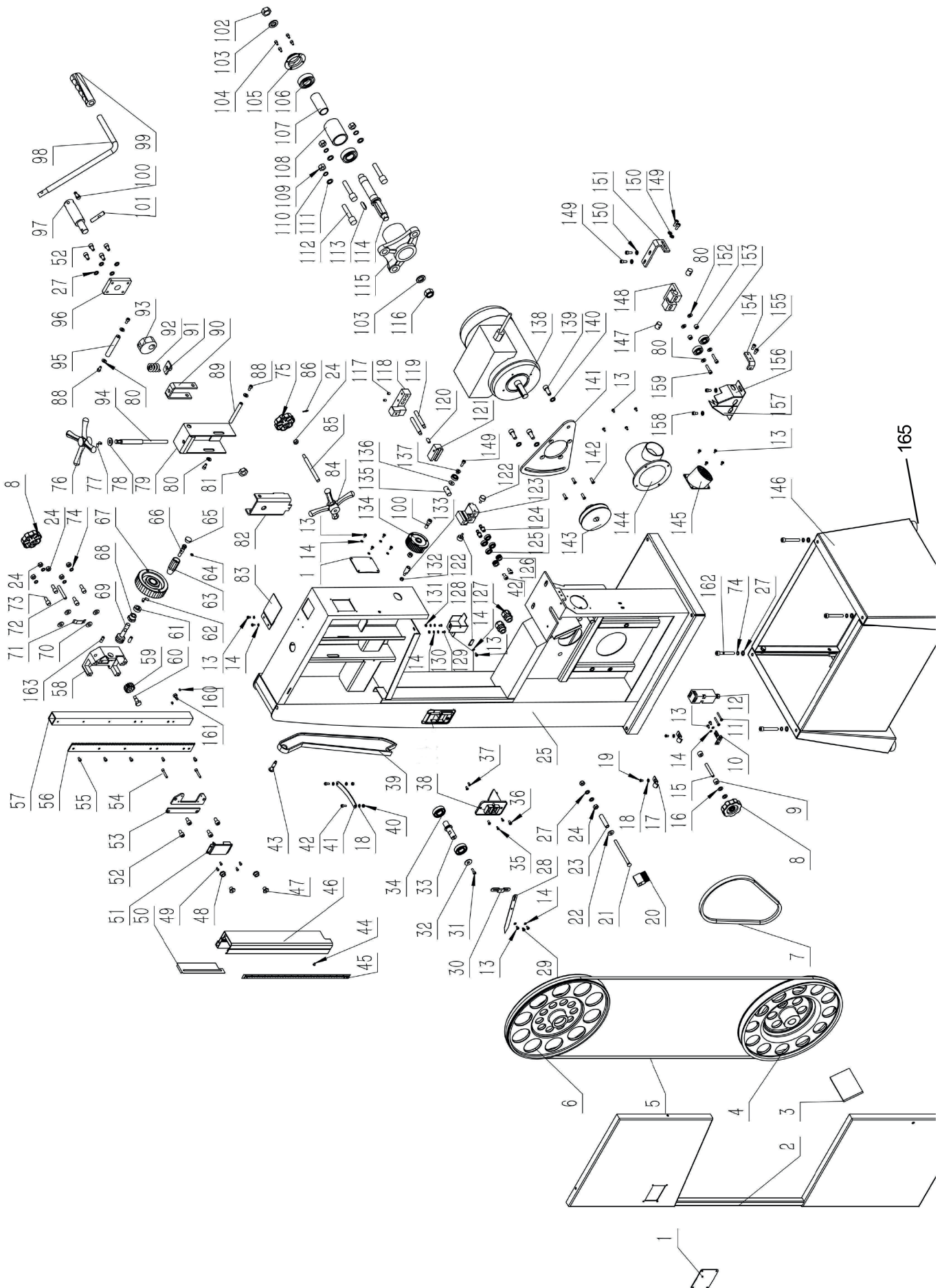
<b>Daily -</b>	
●	Keep the machine clean. Use extraction.
●	Check blade condition keeping a close eye out for missing teeth and small fatigue cracks.

<b>Weekly -</b>	<b>Carry out the above checks, plus</b>
●	Open the top and bottom wheel covers and clean out all saw dust.
●	Add in wax cast iron tables.
●	Clean impacted 'crud' from the tyres, NOTE: Do not use solvents around tires. If signs of wear or deformation occur, replace the tires.

<b>Monthly -</b>	<b>Carry out the above checks, plus</b>
●	Check drive belt condition and tension.
●	Ensure that all guide bearings are moving freely.
●	Check fence for alignment and squareness to blade.

# EXPLODED DIAGRAM/PARTS LISTS

(MJ3435-A)





# EXPLODED DIAGRAM/PARTS LISTS

## (MJ3435-A)

No.	Description	QTY
1	Sight Glass	2
2	Conjoined Door	1
3	Wood Insert	1
4	Lower Wheel	1
5	Saw Blade	1
6	Upper Wheel	1
7	Drive Belt	1
8	Locking Knob	2
9	Bushing	2
10	Limit Switch Key	1
11	Cross Recessed Pan Head Screw M4X30	2
12	Limit Switch	1
13	Cross Recessed Pan Head Screw M4X8	19
14	Washer 4	15
15	Hex Socket Set Screw M8X65	1
16	Washer 8	2
17	Cord Clip	2
18	Washer 5	1
19	Cross Recessed Pan Head Screw M5X8	2
20	Brush	1
21	Semi-Round Step Bolt M8X110	1
22	Thick Washer 8Mm	1
23	Spacer Bushing	1
24	Hex Nut M8	7
25	Saw Body	1
27	Washer 8	6
28	Pointer	1
29	Pointer Screw	1
30	Adjustable Pointer Mount	1
31	Hex Socket Cap Head Bolt M6X20	1
32	Big Washer 8	1
33	Upper Wheel Shaft	1
34	Deep Groove Ball Bearing 6203-2RZ	2
35	Cross Recessed Tapping Screw 3X10	2
36	Cross Recessed Pan Head Screw M5X10	2
37	Cross Recessed Countersunk Screw M4X12	2
38	Power Switch	1
39	Push Stick	1
43	Screw,Push Stick	1
44	Cross Recessed Pan Head Screw M3X5	1
45	Scale,Upper Guide	1
46	Blade Guard	1
47	Adjustable Cushion B	2

No.	Description	QTY
48	Adjustable Cushion A	2
49	Hex Socket Pan Head Screw M4X8	4
50	Protection Board	1
51	Gear Box Cover	1
52	Hex Socket Cap Head Bolt M8X16	8
53	Steel Plate	1
54	Hex Socket Cap Head Bolt M5X30	2
55	Hex Socket Cap Head Bolt M5X8	5
56	Upper Guide Rack	1
57	Upper Guide Square Tube	1
58	Upper Guide Mount	1
59	Lifting Gear,Upper Guide	1
60	Lifting Gear Screw	1
61	Worm Circlip	1
62	Hex Socket Set Screw M6X12	2
63	Handwheel Knob	1
64	"O" Ring	2
65	End Cap,Knob	1
66	Screw,Handwheel Knob	1
67	Handwheel	1
68	Bushing	1
69	Worm	1
70	Big Washer 8	4
71	Press Plate	1
72	Hex Socket Set Screw M8X50	1
73	Adjusting Bolt	4
74	Spring Washer 8	4
75	Locking Knob	1
76	Adjusting Handle	1
77	Hex Socket Set Screws M6X10	2
78	Big Washer 10	1
79	Guide Plate	1
80	Big Washer 6	8
81	Hex Nut M16	1
82	Upper Wheel Axis Seat	1
83	Hinge Plate	1
84	Adjusting Handle	1
85	Screw	1
86	Spring Pin 3X20	1
88	Hex Socket Cap Head Bolt M6X12	6
89	Tension Shaft	1
90	U Bracket	1

Continues over...

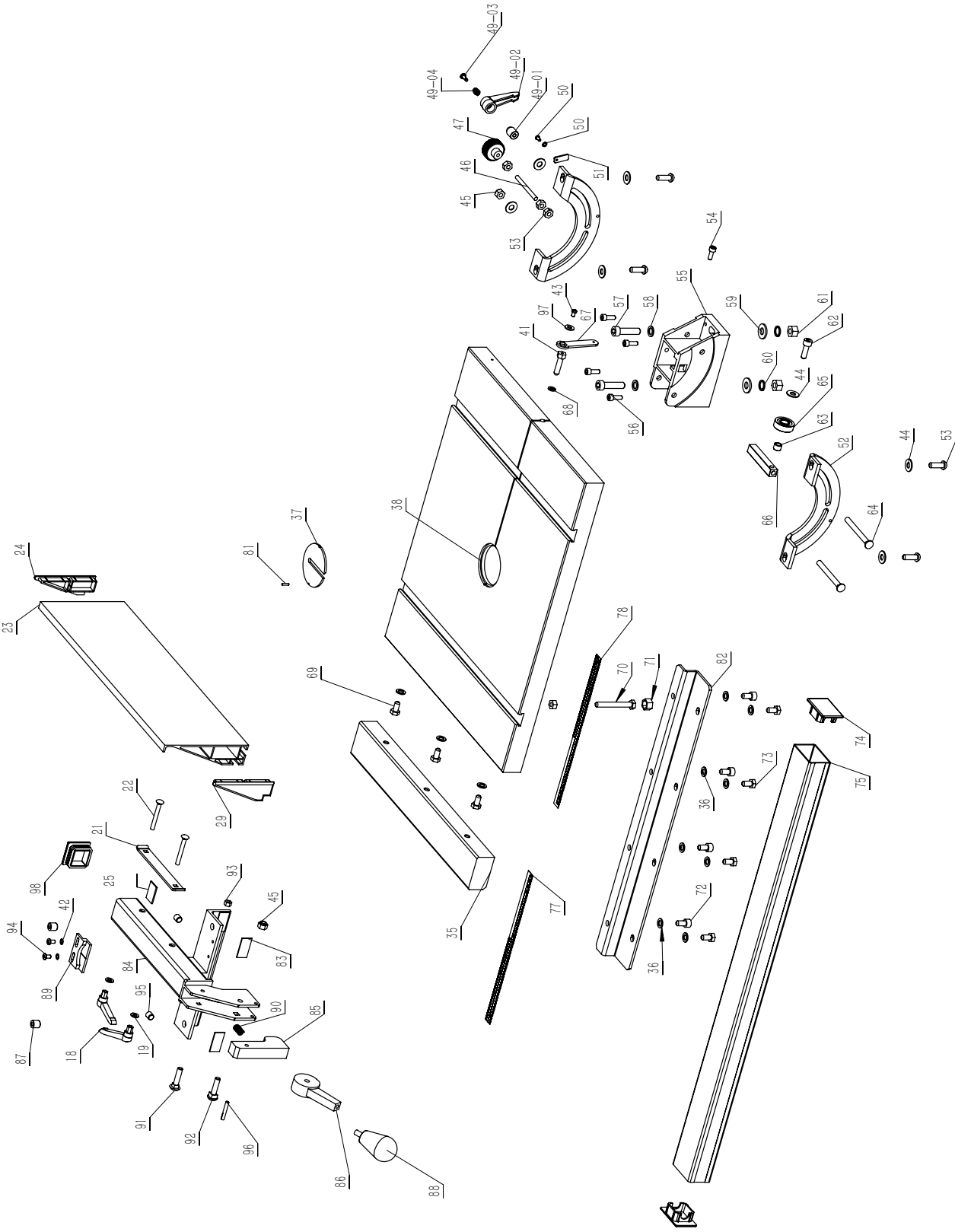
# EXPLODED DIAGRAM/PARTS LISTS

## (MJ3435-A)

No.	Description	QTY
91	Nut Board	1
92	Spring	1
93	Lifting Eccentric	1
94	Blade Tension Shaft	1
95	Quick Tension Shaft	1
96	Eccentric Base	1
97	Eccentric Shaft	1
98	Tension Handle	1
99	Tension Handle Grip	1
100	Hex Socket Cap Head Bolt M8X25	1
101	Stopping Shaft,Blade Tension	1
102	Hex Nut M18X1.5	1
103	Washer 18	2
104	Hex Socket Cap Head Bolt M5X10	4
105	Cover	1
106	Bearing 6205	2
107	Sleeve B	1
108	Sleeve A	1
109	Hex Nut M12	3
110	Spring Washer 12	3
111	Washer 12	3
112	Adjusting Bolt	3
113	Round Key 8X50	1
114	Lower Wheel Shaft	1
115	Lower Wheel Bracket	1
116	Plastic Self-Locking Nut M18X1.5(Left)	1
117	Hex Socket Set Screw M6X8	2
118	Upper Guide Mount	1
119	Guide Shaft	2
120	Hex Socket Set Screw M8X16	1
121	Rail	1
122	Locking Nut	2
123	Mounting Base,Upper Guide	1
124	Eccentric Shaft,Upper Guide	2
125	Bearing 61900	5
126	Bearing Bush	2
127	Strain Relief M20	2
128	Pointer	1
129	Protection Board	1

No.	Description	QTY
130	Cross Recessed Pan Head Screw M4X10	2
131	Hex Nut M4	2
132	Hex Nut M6	1
133	Door Shaft	1
134	Door Lock Knob	1
135	Bearing Nut	1
136	Big Washer 6	1
137	Bearing Spacer Bushing	1
138	Motor	1
139	Hex Socket Cap Head Bolt M10X30	3
140	Washer 10	3
141	Motor Plate	1
142	Cross Recessed Countersunk Screw M6X16	4
143	Motor Pulley	1
144	Lower Outlet B	1
145	Side Outlet A	1
146	Cabinet Stand	1
147	Bearing Nut	2
148	Lower Guide Mount	1
149	Hex Socket Cap Head Bolt M6X16	4
150	Washer 6	6
151	Slide Plate,Lower Guide	1
152	Short Bushing,Bearing	2
153	Bearing 6201	2
154	Mounting Board	1
155	Hex Socket Cap Head Bolt M6X8	2
156	Right Guard	1
157	Left Guard	1
158	Hex Socket Cap Head Bolt M6X12	2
159	Hex Socket Cap Head Bolt M6X30	2
160	Hex Socket Set Screw M5X6	2
161	Hex Bolt M6X16	1
162	Hex Socket Cap Head Bolt M8X60	4
163	Set Screw	2
165	Screw	4

(MJ3435-B)



# EXPLODED DIAGRAM/PARTS LISTS

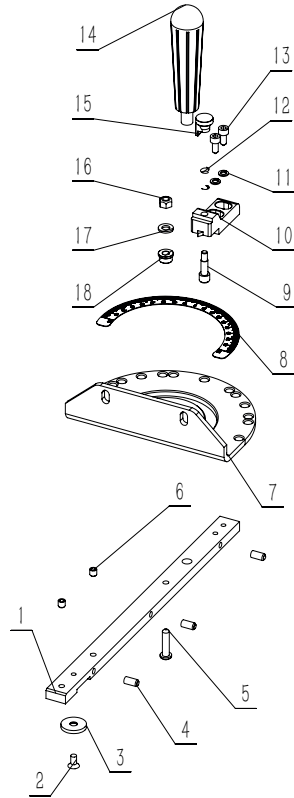
## (MJ3435-B)

No.	Description	QTY
18	Ratchet Lever	2
19	Washer 6	2
21	Lock Bar	1
22	Step Bolt M6X55	2
23	Rip Fence	1
24	End Cap, Rip Fence	1
25	Plate	1
29	Front Cap, Rip Fence	1
35	Extension Table	1
36	Washer 8	11
37	Insert	1
38	Worktable	1
41	Pin	1
42	Washer 5Mm	2
44	Big Washer 8Mm	5
45	Self-Locking Nut M8	2
46	Hex Socket Set Screw M6X70	1
47	Gear Handle	1
49	Adjustable Knob M8	1
50	Hex Socket Pan Head Screw M5X6	1
51	Pointer	1
52	Upper Table Trunnion	2
53	Hex Socket Pan Head Bolt M8X20	4
54	Hex Socket Set Screw M6X18	1
55	Lower Table Trunnion	1
56	Hex Socket Cap Head Bolt M6X20	4
57	Hex Socket Cap Head Bolt M10X40	2
58	Washer 10	2
59	Big Washer 10	2
60	Spring Washer 10	2
61	Hex Nut M10	2
62	Hex Socket Cap Head Bolt M8X25	1
63	Bearing Bushing	1

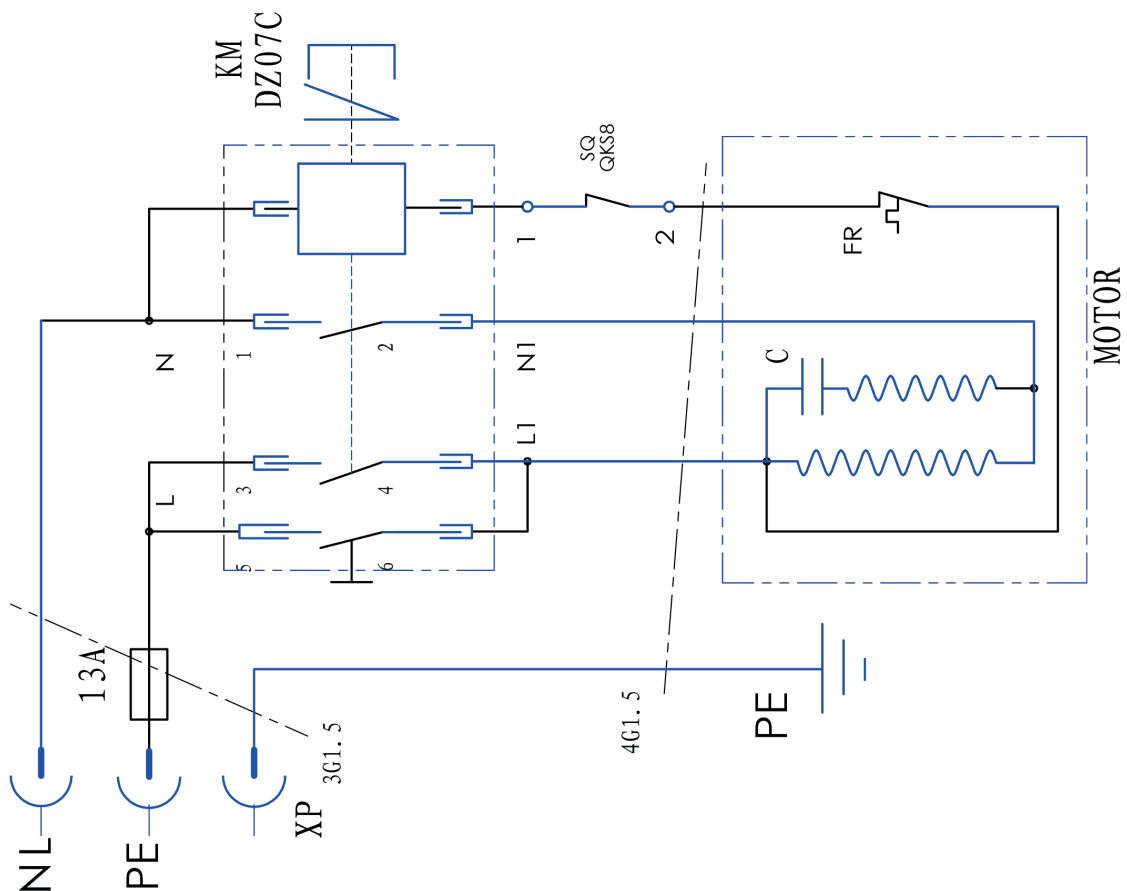
No.	Description	QTY
64	Step Bolt M8X85	2
65	Bearing 6201	1
66	Lower Bearing Square Pole	1
67	Table Pin Wrench	1
68	Split Washer 7	1
69	Hex Bolt M8X16	3
70	Hex Bolt M8X65	1
71	Protection Cover	1
72	Hex Socket Cap Head Bolt M8X16	4
73	Hex Bolt M8X12	4
74	End Cap, Fence Rail	2
75	Fence Rail	1
77	Left Scale,Fence Rail	1
78	Right Scale,Fence Rail	1
81	Spring Pin 3X10	1
82	Mouting Bracket, Fence Rail	1
83	Pad	1
84	Sliding Rail Carrier	1
85	Locking Block	1
86	Locking Cam	1
87	Nylon Screw M12X12	2
88	Locking Handle	1
89	Pointer	1
90	Spring	1
91	Semi-Round Step Bolt M6X35	1
92	Semi-Round Step Bolt M8X35	1
93	Self-Locking Nut M6	1
94	Cross Recessed Pan Head Screw M5X10	2
95	Hex Socket Set Screw M10X10	2
96	Spring Pin 5X32	1
97	Big Washer 5	1
98	End Cap, Fence Body	1

## (MJ3435-C)

No.	Description	QTY
1	Mitre Gauge Guide Rod	1
2	Cross Recessed Countersunk Screw	1
3	Rail Washer	1
4	Hex Socket Set Screw M6X12	3
5	Hex Socket Pan Head Screw M6X20	1
6	Hex Socket Set Screw M6X8	2
7	Mitre Gauge Base	1
8	Scale	1
9	Stop Pin	1
10	Block Indicator	1
11	Spring Washer 5Mm	2
12	Stop Spring	1
13	Hex Socket Cap Head Bolt M5X12	2
14	Mitre Gauge Knob	1
15	Stopping Knob	1
16	Self-Locking Nut M6	1
17	Washer 6Mm	1
18	Stop Pin	1



## WIRING DIAGRAM



# DECLARATION OF CONFORMITY

---



**Axminster Tool Centre Ltd**



## UK DECLARATION OF CONFORMITY 'original'

*Product model:* AP2920B Bandsaw

*Name and address of the manufacturer:* Axminster Tool Centre Ltd, Unit 10 Weycroft Avenue, Axminster, Devon EX13 5PH, United Kingdom

This declaration of conformity is issued under the sole responsibility of the manufacturer.

*Object of the declaration:* 108517 AP2920B Bandsaw

*The object of the declaration described above is in conformity with the relevant GB legislation:*

Supply of Machinery (Safety) Regulations 2008 as amended.  
Electromagnetic Compatibility Regulations 2016 as amended.

*References to the relevant harmonised standards used or references to the other technical specifications in relation to which conformity is declared:*

**EN 1807-2:2013** Safety of woodworking machines - Band sawing machines - Part 2: Log sawing machines

**EN 60204-1:2018** Safety of machinery - Electrical equipment of machines - Part 1: General requirements (IEC 60204-1:2016, modified)

**EN IEC 55014-1:2021** Electromagnetic compatibility - Requirements for household appliances, electric tools and similar apparatus - Part 1: Emission

**EN IEC 55014-2:2021** Electromagnetic compatibility - Requirements for household appliances, electric tools and similar apparatus - Part 2: Immunity - Product family standard

**EN IEC 61000-3-2:2019** Electromagnetic compatibility (EMC) - Part 3-2: Limits - Limits for harmonic current emissions (equipment input current  $\leq 16$  A per phase) (IEC 61000-3-2:2018)

**EN 61000-3-3:2013/A1:2019** Electromagnetic compatibility (EMC) - Part 3-3: Limits - Limitation of voltage changes, voltage fluctuations and flicker in public low-voltage supply systems, for equipment with rated current  $\leq 16$  A per phase and not subject to conditional connection (IEC 61000-3-3:2013/A1:2017)

*Additional information:*

*Name and address of person authorised to compile the technical file:* Axminster Tool Centre Ltd, Unit 10 Weycroft Avenue, Axminster, Devon EX13 5PH, United Kingdom

The machinery fulfils all relevant provisions of Supply of Machinery (Safety) Regulations 2008 as amended.

*Signed for and behalf of:* Axminster Tool Centre Ltd;

*(place and date of issue):* Axminster, Devon, United Kingdom, 11<sup>th</sup> October 2022

*(name, function):* Andrew Parkhouse, Supply Chain Director

*Signature:* .....



**Axminster Tool Centre Ltd**



## EC DECLARATION OF CONFORMITY 'original'

*Product model:* AP2920B

*Name and address of the manufacturer:* Axminster Tool Centre Ltd, Unit 10 Weycroft Avenue, Axminster, Devon EX13 5PH, United Kingdom

This declaration of conformity is issued under the sole responsibility of the manufacturer.

*Object of the declaration:* AP2920B Bandsaw 108517

*The object of the declaration described above is in conformity with the relevant GB legislation:*

Supply of Machinery (Safety) Regulations 2008 as amended.  
Electromagnetic Compatibility Regulations 2016 as amended.

*References to the relevant harmonised standards used or references to the other technical specifications in relation to which conformity is declared:*

**EN 1807-2:2013** Safety of woodworking machines - Band sawing machines - Part 2: Log sawing machines

**EN 60204-1:2018** Safety of machinery - Electrical equipment of machines - Part 1: General requirements (IEC 60204-1:2016, modified)

**EN IEC 55014-1:2021** Electromagnetic compatibility - Requirements for household appliances, electric tools and similar apparatus - Part 1: Emission

**EN IEC 55014-2:2021** Electromagnetic compatibility - Requirements for household appliances, electric tools and similar apparatus - Part 2: Immunity - Product family standard

**EN IEC 61000-3-2:2019** Electromagnetic compatibility (EMC) - Part 3-2: Limits - Limits for harmonic current emissions (equipment input current  $\leq 16$  A per phase) (IEC 61000-3-2:2018)

**EN 61000-3-3:2013/A1:2019** Electromagnetic compatibility (EMC) - Part 3-3: Limits - Limitation of voltage changes, voltage fluctuations and flicker in public low-voltage supply systems, for equipment with rated current  $\leq 16$  A per phase and not subject to conditional connection (IEC 61000-3-3:2013/A1:2017)

*Additional information:*

*Name and address of person authorised to compile the technical file:* Axminster Tool Centre Ltd, Unit 10 Weycroft Avenue, Axminster, Devon EX13 5PH, United Kingdom

The machinery fulfils all relevant provisions of Supply of Machinery (Safety) Regulations 2008 as amended.

*Signed for and behalf of:* Axminster Tool Centre Ltd;

*(place and date of issue):* Axminster, Devon, United Kingdom, 11<sup>th</sup> October 2022

*(name, function):* Andrew Parkhouse, Supply Chain Director

*Signature:* .....

## The Axminster guarantee

Buy with confidence from Axminster Tools!

So sure are we of the quality, we cover all parts and labour free of charge for three years!



For more information visit [axminstertools.com/3years](https://axminstertools.com/3years)



The packaging is suitable for recycling.  
Please dispose of it in a responsible manner.



### EU Countries Only

Do not dispose of electric tools together with household waste material.  
By law they must be collected and recycled separately.



Axminster Tools, Axminster Devon EX13 5PH

[axminstertools.com](https://axminstertools.com)