

INSTRUCTION MANUAL

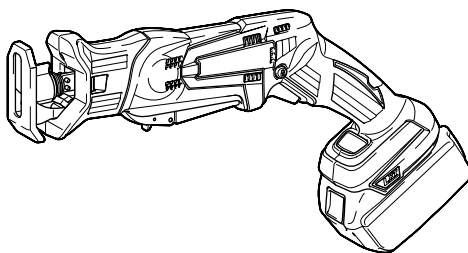

Cordless Recipro Saw

DJR143
DJR145
DJR183
DJR185



014043

IMPORTANT: Read Before Using.

ENGLISH (Original instructions)

SPECIFICATIONS

Model	DJR143	DJR145	DJR183	DJR185
Length of stroke	13 mm			
Strokes per minute (min ⁻¹)	0 - 3,000			
Max. cutting capacities	Pipe	50 mm		
	Wood	50 mm		
Overall length	392 mm (with BL1415 / BL1415N)	392 mm (with BL1815 / BL1815N / BL1820)		
	397 mm (with BL1430 / BL1440)	398 mm (with BL1830 / BL1840 / BL1850)		
Net weight	1.5 kg (with BL1415 / BL1415N)	1.5 kg (with BL1815 / BL1815N / BL1820)		
	1.7 kg (with BL1430 / BL1440)	1.8 kg (with BL1830 / BL1840 / BL1850)		
Rated voltage	D.C. 14.4 V		D.C. 18 V	

- Due to our continuing program of research and development, the specifications herein are subject to change without notice.
- Specifications and battery cartridge may differ from country to country.
- Weight, with battery cartridge, according to EPTA-Procedure 01/2003

END004-6

GEA006-2

Symbols

The following show the symbols used for the equipment. Be sure that you understand their meaning before use.



- Read instruction manual.



- Only for EU countries

Do not dispose of electric equipment or battery pack together with household waste material!

In observance of the European Directives, on Waste Electric and Electronic Equipment and Batteries and Accumulators and Waste Batteries and Accumulators and their implementation in accordance with national laws, electric equipment and batteries and battery pack(s) that have reached the end of their life must be collected separately and returned to an environmentally compatible recycling facility.

ENE020-1

Intended use

The tool is intended for sawing wood, plastic and ferrous materials.

General Power Tool Safety Warnings

⚠ WARNING Read all safety warnings and all instructions. Failure to follow the warnings and instructions may result in electric shock, fire and/or serious injury.

Save all warnings and instructions for future reference.

The term "power tool" in the warnings refers to your mains-operated (corded) power tool or battery-operated (cordless) power tool.

Work area safety

1. **Keep work area clean and well lit.** Cluttered or dark areas invite accidents.
2. **Do not operate power tools in explosive atmospheres, such as in the presence of flammable liquids, gases or dust.** Power tools create sparks which may ignite the dust or fumes.
3. **Keep children and bystanders away while operating a power tool.** Distractions can cause you to lose control.

Electrical safety

4. **Power tool plugs must match the outlet. Never modify the plug in any way. Do not use any adapter plugs with earthed (grounded) power tools.** Unmodified plugs and matching outlets will reduce risk of electric shock.
5. **Avoid body contact with earthed or grounded surfaces such as pipes, radiators, ranges and**

- refrigerators.** There is an increased risk of electric shock if your body is earthed or grounded.
6. **Do not expose power tools to rain or wet conditions.** Water entering a power tool will increase the risk of electric shock.
 7. **Do not abuse the cord. Never use the cord for carrying, pulling or unplugging the power tool. Keep cord away from heat, oil, sharp edges or moving parts.** Damaged or entangled cords increase the risk of electric shock.
 8. **When operating a power tool outdoors, use an extension cord suitable for outdoor use.** Use of a cord suitable for outdoor use reduces the risk of electric shock.
 9. **If operating a power tool in a damp location is unavoidable, use a ground fault circuit interrupter (GFCI) protected supply.** Use of an GFCI reduces the risk of electric shock.

Personal safety

10. **Stay alert, watch what you are doing and use common sense when operating a power tool. Do not use a power tool while you are tired or under the influence of drugs, alcohol or medication.** A moment of inattention while operating power tools may result in serious personal injury.
11. **Use personal protective equipment. Always wear eye protection.** Protective equipment such as dust mask, non-skid safety shoes, hard hat, or hearing protection used for appropriate conditions will reduce personal injuries.
12. **Prevent unintentional starting. Ensure the switch is in the off-position before connecting to power source and/or battery pack, picking up or carrying the tool.** Carrying power tools with your finger on the switch or energising power tools that have the switch on invites accidents.
13. **Remove any adjusting key or wrench before turning the power tool on.** A wrench or a key left attached to a rotating part of the power tool may result in personal injury.
14. **Do not overreach. Keep proper footing and balance at all times.** This enables better control of the power tool in unexpected situations.
15. **Dress properly. Do not wear loose clothing or jewellery. Keep your hair, clothing, and gloves away from moving parts.** Loose clothes, jewellery or long hair can be caught in moving parts.
16. **If devices are provided for the connection of dust extraction and collection facilities, ensure these are connected and properly used.** Use of dust collection can reduce dust-related hazards.

Power tool use and care

17. **Do not force the power tool. Use the correct power tool for your application.** The correct power tool will do the job better and safer at the

rate for which it was designed.

18. **Do not use the power tool if the switch does not turn it on and off.** Any power tool that cannot be controlled with the switch is dangerous and must be repaired.
19. **Disconnect the plug from the power source and/or the battery pack from the power tool before making any adjustments, changing accessories, or storing power tools.** Such preventive safety measures reduce the risk of starting the power tool accidentally.
20. **Store idle power tools out of the reach of children and do not allow persons unfamiliar with the power tool or these instructions to operate the power tool.** Power tools are dangerous in the hands of untrained users.
21. **Maintain power tools. Check for misalignment or binding of moving parts, breakage of parts and any other condition that may affect the power tool's operation. If damaged, have the power tool repaired before use.** Many accidents are caused by poorly maintained power tools.
22. **Keep cutting tools sharp and clean.** Properly maintained cutting tools with sharp cutting edges are less likely to bind and are easier to control.
23. **Use the power tool, accessories and tool bits etc. in accordance with these instructions, taking into account the working conditions and the work to be performed.** Use of the power tool for operations different from those intended could result in a hazardous situation.

Battery tool use and care

24. **Recharge only with the charger specified by the manufacturer.** A charger that is suitable for one type of battery pack may create a risk of fire when used with another battery pack.
25. **Use power tools only with specifically designated battery packs.** Use of any other battery packs may create a risk of injury and fire.
26. **When battery pack is not in use, keep it away from other metal objects, like paper clips, coins, keys, nails, screws or other small metal objects, that can make a connection from one terminal to another.** Shorting the battery terminals together may cause burns or a fire.
27. **Under abusive conditions, liquid may be ejected from the battery; avoid contact. If contact accidentally occurs, flush with water. If liquid contacts eyes, additionally seek medical help.** Liquid ejected from the battery may cause irritation or burns.

Service

28. **Have your power tool serviced by a qualified repair person using only identical replacement parts.** This will ensure that the safety of the power tool is maintained.

29. Follow instruction for lubricating and changing accessories.
30. Keep handles dry, clean and free from oil and grease.

GEB048-2

CORDLESS RECIPRO SAW SAFETY WARNINGS

1. Hold power tool by insulated gripping surfaces, when performing an operation where the cutting accessory may contact hidden wiring. Cutting accessory contacting a "live" wire may make exposed metal parts of the power tool "live" and could give the operator an electric shock.
2. Use clamps or another practical way to secure and support the workpiece to a stable platform. Holding the work by hand or against your body leaves it unstable and may lead to loss of control.
3. Always use safety glasses or goggles. Ordinary eye or sun glasses are NOT safety glasses.
4. Avoid cutting nails. Inspect workpiece for any nails and remove them before operation.
5. Do not cut oversize workpiece.
6. Check for the proper clearance beyond the workpiece before cutting so that the blade will not strike the floor, workbench, etc.
7. Hold the tool firmly.
8. Make sure the blade is not contacting the workpiece before the switch is turned on.
9. Keep hands away from moving parts.
10. Do not leave the tool running. Operate the tool only when hand-held.
11. Always switch off and wait for the blade to come to a complete stop before removing the blade from the workpiece.
12. Do not touch the blade or the workpiece immediately after operation; they may be extremely hot and could burn your skin.
13. Do not operate the tool at no-load unnecessarily.
14. Always use the correct dust mask/respirator for the material and application you are working with.
15. Some material contains chemicals which may be toxic. Take caution to prevent dust inhalation and skin contact. Follow material supplier safety data.

SAVE THESE INSTRUCTIONS.

WARNING:

DO NOT let comfort or familiarity with product (gained from repeated use) replace strict adherence to safety rules for the subject product. MISUSE or failure to follow the safety rules stated in this instruction manual may cause serious personal injury.

IMPORTANT SAFETY INSTRUCTIONS

FOR BATTERY CARTRIDGE

1. Before using battery cartridge, read all instructions and cautionary markings on (1) battery charger, (2) battery, and (3) product using battery.
2. Do not disassemble battery cartridge.
3. If operating time has become excessively shorter, stop operating immediately. It may result in a risk of overheating, possible burns and even an explosion.
4. If electrolyte gets into your eyes, rinse them out with clear water and seek medical attention right away. It may result in loss of your eyesight.
5. Do not short the battery cartridge:
 - (1) Do not touch the terminals with any conductive material.
 - (2) Avoid storing battery cartridge in a container with other metal objects such as nails, coins, etc.
 - (3) Do not expose battery cartridge to water or rain.

A battery short can cause a large current flow, overheating, possible burns and even a breakdown.

6. Do not store the tool and battery cartridge in locations where the temperature may reach or exceed 50 ° C (122 ° F).
7. Do not incinerate the battery cartridge even if it is severely damaged or is completely worn out. The battery cartridge can explode in a fire.
8. Be careful not to drop or strike battery.
9. Do not use a damaged battery.
10. Follow your local regulations relating to disposal of battery.

SAVE THESE INSTRUCTIONS.

Tips for maintaining maximum battery life

1. Charge the battery cartridge before completely discharged.
Always stop tool operation and charge the battery cartridge when you notice less tool power.
2. Never recharge a fully charged battery cartridge. Overcharging shortens the battery service life.
3. Charge the battery cartridge with room temperature at 10 ° C - 40 ° C (50 ° F - 104 ° F). Let a hot battery cartridge cool down before charging it.
4. Charge the battery cartridge once in every six months if you do not use it for a long period of time.

FUNCTIONAL DESCRIPTION

⚠CAUTION:

- Always be sure that the tool is switched off and the battery cartridge is removed before adjusting or checking function on the tool.

Installing or removing battery cartridge

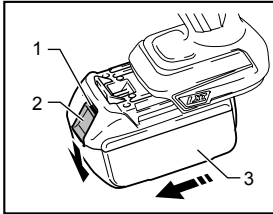

1. Red indicator
2. Button
3. Battery cartridge

014044

⚠CAUTION:

- Always switch off the tool before installing or removing of the battery cartridge.
- **Hold the tool and the battery cartridge firmly when installing or removing battery cartridge.** Failure to hold the tool and the battery cartridge firmly may cause them to slip off your hands and result in damage to the tool and battery cartridge and a personal injury.

To remove the battery cartridge, slide it from the tool while sliding the button on the front of the cartridge.

To install the battery cartridge, align the tongue on the battery cartridge with the groove in the housing and slip it into place. Insert it all the way until it locks in place with a little click. If you can see the red indicator on the upper side of the button, it is not locked completely.

⚠CAUTION:

- Always install the battery cartridge fully until the red indicator cannot be seen. If not, it may accidentally fall out of the tool, causing injury to you or someone around you.
- Do not install the battery cartridge forcibly. If the cartridge does not slide in easily, it is not being inserted correctly.

Battery protection system (Lithium-ion battery with star marking)

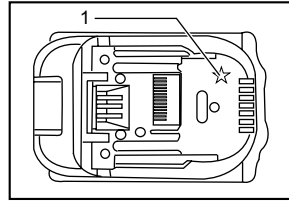

1. Star marking

012128

Lithium-ion batteries with a star marking are equipped with a protection system. This system automatically cuts off power to the tool to extend battery life.

The tool will automatically stop during operation if the tool and/or battery are placed under one of the following conditions:

- **Overloaded:**

The tool is operated in a manner that causes it to draw an abnormally high current. In this situation, release the switch lever/trigger on the tool and stop the application that caused the tool to become overloaded. Then pull the switch lever/trigger again to restart. If the tool does not start, the battery is overheated. In this situation, let the battery cool before pulling the switch lever/trigger again.
- **Low battery voltage:**

The remaining battery capacity is too low and the tool will not operate. In this situation, remove and recharge the battery.

Switch action

⚠CAUTION:

- Before installing the battery cartridge into the tool, always check to see that the switch lever/trigger actuates properly and returns to the "OFF" position when released.

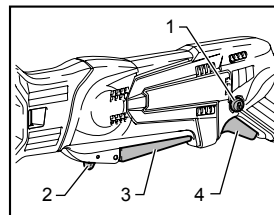

1. Lock-off button
2. Lock-off lever
3. Switch lever
4. Switch trigger

014050

To prevent the switch lever/trigger from accidentally pulled, the lock-off lever/button are provided.

To start the tool, pull either switch lever or trigger.

- For the switch lever, pull the lock-off lever and then pull the switch lever to start the tool.
- For the switch trigger, depress the lock-off button and then pull the switch trigger to start the tool. The lock-off button can be pressed from either right or left.

The tool speed is increased by increasing pressure on the switch lever/trigger. Release the switch lever/trigger to stop.

NOTICE:

Do not pull the switch lever/trigger hard without pulling the lock-off lever/button. This can cause switch breakage.

Lighting up the front lamp

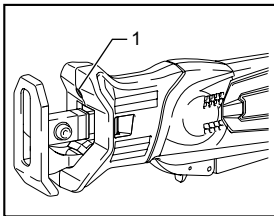

1. Lamp

014053

⚠CAUTION:

- Do not look in the light or see the source of light directly.

Pull the switch lever/trigger to light up the lamp. The lamp keeps on lighting while the switch lever/trigger is being pulled.

The lamp automatically turns off 10-15 seconds after releasing the switch lever/trigger.

Adjusting the shoe

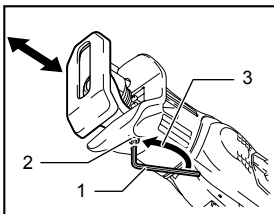

1. Hex wrench
2. Hex bolt
3. Loosen

014201

When the blade loses its cutting efficiency in one place along its cutting edge, reposition the shoe to utilize a sharp, unused portion of its cutting edge. This will help to lengthen the life of the blade.

To reposition the shoe, loosen the bolt with hex wrench. Slide the shoe to the desired position and then tighten the bolt firmly.

ASSEMBLY

⚠CAUTION:

- Always be sure that the tool is switched off and the battery cartridge is removed before carrying out any work on the tool.

Installing or removing the saw blade

⚠CAUTION:

- Always clean out all chips or foreign matter adhering to the blade, blade clamp and/or slider. Failure to do so may cause insufficient tightening of the blade, resulting in a serious injury.

For Model DJR143, DJR183

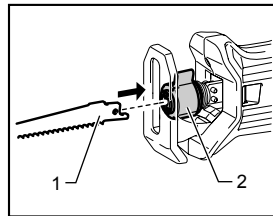

1. Recipro saw blade
2. Blade clamp sleeve

014058

Insert the reciprocating saw blade into the blade clamp as far as it will go. The blade clamp sleeve rotates and fixes the saw blade. Make sure that the saw blade cannot be extracted even though you try to pull it out.

⚠CAUTION:

- If you do not insert the saw blade deep enough, the saw blade may be ejected unexpectedly during operation. This can be extremely dangerous.

NOTE:

- You can not use the jig saw blade with DJR143 or DJR183

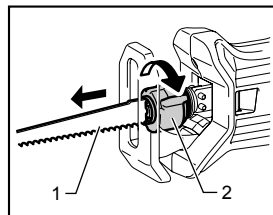

1. Saw blade
2. Blade clamp sleeve

014059

To remove the saw blade, rotate the blade clamp sleeve in the direction of the arrow fully. The saw blade is removed and the blade clamp sleeve is fixed at the released position.

NOTE:

- If you remove the saw blade without rotating the blade clamp sleeve fully, the sleeve may not be fixed. In this case, rotate the blade clamp sleeve fully, then make the sleeve fixed at the released position.

For Model DJR145, DJR185

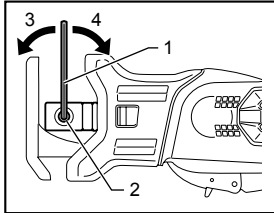

014045

1. Hex wrench
2. Bolt
3. Loosen
4. Tighten

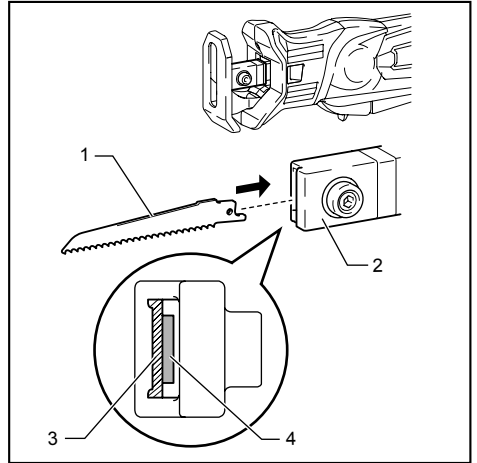

1. Saw blade
2. Blade clamp
3. Hole for reciprocating saw blade
4. Hole for jig saw blade

014047

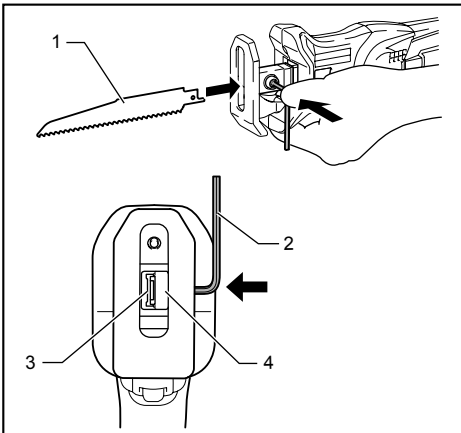

1. Recipro saw blade
2. Hex wrench
3. Hole for reciprocating saw blade
4. Blade clamp

014048

To install the saw blade, loosen the bolt by hex wrench. When installing a reciprocating saw blade, press the bolt with the hex wrench to open the slot during inserting the blade.

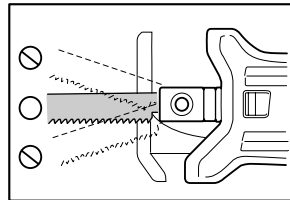

014086

You can use both jig saw blades (B type) and reciprocating saw blades according to your work. Insert the saw blade straight into the blade clamp and tighten it by hex wrench. Pull the saw blade lightly to make sure that the saw blade does not fall off during operation.

To remove the saw blade, follow the installation procedure in reverse.

Hex wrench storage

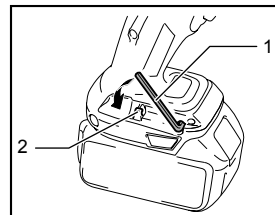

1. Hex wrench
2. Protrusion

014202

When not in use, store the hex wrench as shown in the figure to keep it from being lost.

OPERATION

⚠CAUTION:

- Always press the shoe firmly against the workpiece during operation. If the shoe is held away from the workpiece during operation, strong vibration and/or twisting will be produced, causing the blade to snap dangerously.
- Always wear gloves to protect your hands from hot flying chips when cutting metal.
- Be sure to always wear suitable eye protection which conforms with current national standards.
- Always use a suitable coolant (cutting oil) when cutting metal. Failure to do so will cause premature blade wear.

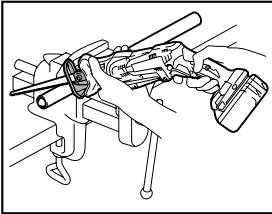

014054

Press the shoe firmly against the workpiece. Do not allow the tool to bounce. Bring the saw blade into light contact with the workpiece. First, make a pilot groove using a slower speed. Then use a faster speed to continue cutting.

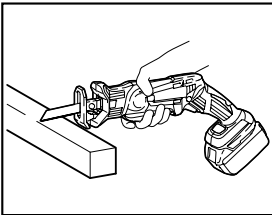

014056

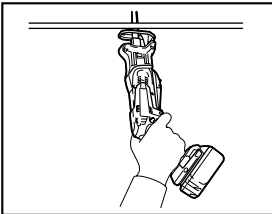

014055

- You can use the switch lever or trigger according to your work.

NOTE:

- If the tool is operated continuously until the battery cartridge has discharged, allow the tool to rest for 15 minutes before proceeding with a fresh battery.

MAINTENANCE

⚠CAUTION:

- Always be sure that the tool is switched off and the battery cartridge is removed before attempting to perform inspection or maintenance.
- Never use gasoline, benzene, thinner, alcohol or the like. Discoloration, deformation or cracks may result.

To maintain product SAFETY and RELIABILITY, repairs, any other maintenance or adjustment should be performed by Makita Authorized Service Centers, always using Makita replacement parts.

OPTIONAL ACCESSORIES

⚠CAUTION:

- These accessories or attachments are recommended for use with your Makita tool specified in this manual. The use of any other accessories or attachments might present a risk of injury to persons. Only use accessory or attachment for its stated purpose.

If you need any assistance for more details regarding these accessories, ask your local Makita Service Center.

- Recipro saw blades
- Jig saw blades (only for Model DJR145, DJR185)
- Makita genuine battery and charger

NOTE:

- Some items in the list may be included in the tool package as standard accessories. They may differ from country to country.

Makita Corporation